



RIGOL

DHO1000 Series

Digital Oscilloscope

Quick Guide

Oct.2022

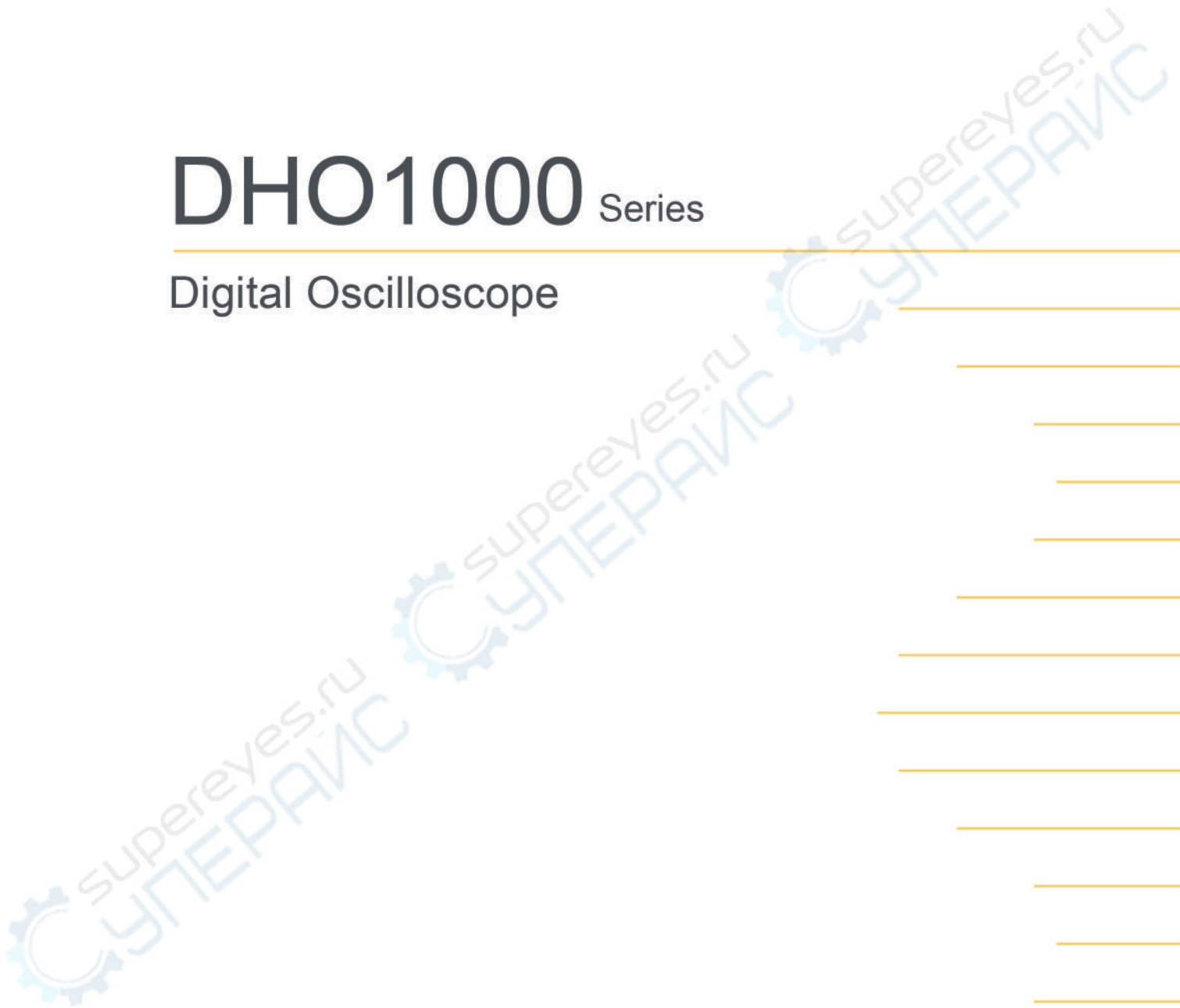

Guaranty and Declaration

Copyright

© 2022 RIGOL TECHNOLOGIES CO., LTD. All Rights Reserved.

Trademark Information

RIGOL® is the trademark of RIGOL TECHNOLOGIES CO., LTD.

Software Version

Software upgrade might change or add product features. Please acquire the latest software version from **RIGOL** website or contact **RIGOL** to upgrade the software.

Notices

- RIGOL products are covered by P.R.C. and foreign patents, issued and pending.
- RIGOL reserves the right to modify or change parts of or all the specifications and pricing policies at the company's sole decision.
- Information in this publication replaces all previously released materials.
- Information in this publication is subject to change without notice.
- RIGOL shall not be liable for either incidental or consequential losses in connection with the furnishing, use, or performance of this manual, as well as any information contained.
- Any part of this document is forbidden to be copied, photocopied, or rearranged without prior written approval of RIGOL.

Product Certification

RIGOL guarantees that this product conforms to the national and industrial standards in China as well as the ISO9001:2015 standard and the ISO14001:2015 standard. Other international standard conformance certifications are in progress.

Contact Us

If you have any problem or requirement when using our products or this manual, please contact RIGOL.

E-mail: service@rigol.com

Website: <http://www.rigol.com>

1 Safety Requirement

1.1 General Safety Summary

Please review the following safety precautions carefully before putting the instrument into operation so as to avoid any personal injury or damage to the instrument and any product connected to it. To prevent potential hazards, please follow the instructions specified in this manual to use the instrument properly.

- | | | | |
|---|--|----|--|
| 1 | Only the exclusive power cord designed for the instrument and authorized for use within the destination country could be used. | 9 | Do not operate the instrument with suspected failures. |
| 2 | Ensure that the instrument is safely grounded. | 10 | Provide adequate ventilation. |
| 3 | Observe all terminal ratings. | 11 | Do not operate in wet conditions. |
| 4 | Use proper overvoltage protection. | 12 | Do not operate in an explosive atmosphere. |
| 5 | Do not operate without covers. | 13 | Keep instrument surfaces clean and dry. |
| 6 | Do not insert objects into the air outlet. | 14 | Prevent electrostatic impact. |
| 7 | Use the proper fuse. | 15 | Handle with caution. |
| 8 | Avoid circuit or wire exposure. | | |



WARNING

Equipment meeting Class A requirements may not offer adequate protection to broadcast services within residential environment.

1.2 Safety Notices and Symbols

Safety Notices in this Manual:



WARNING

Indicates a potentially hazardous situation or practice which, if not avoided, will result in serious injury or death.



CAUTION

Indicates a potentially hazardous situation or practice which, if not avoided, could result in damage to the product or loss of important data.

Safety Notices on the Product:

- **DANGER**

It calls attention to an operation, if not correctly performed, could result in injury or hazard immediately.

- **WARNING**

It calls attention to an operation, if not correctly performed, could result in potential injury or hazard.

- **CAUTION**

It calls attention to an operation, if not correctly performed, could result in damage to the product or other devices connected to the product.

Safety Symbols on the Product:

Hazardous Voltage



Safety Warning



Protective Earth Terminal



Chassis Ground



Test Ground

1.3 Measurement Category

Measurement Category

This instrument can make measurements in Measurement Category I.

**WARNING**

This instrument can only be used for measurements within its specified measurement categories.

Measurement Category Definitions

- **Measurement category I** is for measurements performed on circuits not directly connected to MAINS. Examples are measurements on circuits not derived from MAINS, and specially protected (internal) MAINS derived circuits. In the latter case, transient stresses are variable. Thus, you must know the transient withstand capability of the equipment.
- **Measurement category II** is for measurements performed on circuits directly connected to low voltage installation. Examples are measurements on household appliances, portable tools and similar equipment.
- **Measurement category III** is for measurements performed in the building installation. Examples are measurements on distribution boards, circuit-breakers, wiring (including cables, bus-bars, junction boxes, switches and socket-outlets) in the fixed installation, and equipment for industrial use and some other

equipment. For example, stationary motors with permanent connection to a fixed installation.

- **Measurement category IV** is for measurements performed at the source of a low-voltage installation. Examples are electricity meters and measurements on primary overcurrent protection devices and ripple control units.

1.4 Ventilation Requirement

This instrument uses a fan to force cooling. Please make sure that the air inlet and outlet areas are free from obstructions and have free air. When using the instrument in a bench-top or rack setting, provide at least 10 cm clearance beside, above and behind the instrument for adequate ventilation.



CAUTION

Inadequate ventilation may cause an increase of temperature in the instrument, which would cause damage to the instrument. So please keep the instrument well ventilated and inspect the air outlet and the fan regularly.

1.5 Working Environment

Temperature

Operating: 0°C to +50°C

Non-operating: -30°C to +60°C

Humidity

- **Operating:**
 - Below +30°C: ≤90% RH (without condensation)
 - +30°C to +40°C: ≤75% RH (without condensation)
 - +40°C to +50°C: ≤45% RH (without condensation)
- **Non-operating:**
 - Below +60°C: ≤90% RH (without condensation)

WARNING

To avoid short circuit inside the instrument or electric shock, never operate the instrument in a humid environment.

Altitude

- **Operating:** below 3 km
- **Non-operating:** below 15 km

Protection Level Against Electric Shock

ESD $\pm 8\text{kV}$

Installation (Overvoltage) Category

This product is powered by mains conforming to installation (overvoltage) category II.



WARNING

Ensure that no overvoltage (such as that caused by a bolt of lightning) can reach the product. Otherwise, the operator might be exposed to the danger of an electric shock.

Installation (Overvoltage) Category Definitions

Installation (overvoltage) category I refers to signal level which is applicable to equipment measurement terminals connected to the source circuit. Among these terminals, precautions are done to limit the transient voltage to a low level.

Installation (overvoltage) category II refers to the local power distribution level which is applicable to equipment connected to the AC line (AC power).

Pollution Degree

Pollution Degree 2

Pollution Degree Definition

- **Pollution Degree 1:** No pollution or only dry, nonconductive pollution occurs. The pollution has no effect. For example, a clean room or air-conditioned office environment.
- **Pollution Degree 2:** Normally only nonconductive pollution occurs. Temporary conductivity caused by condensation is to be expected. For example, indoor environment.
- **Pollution Degree 3:** Conductive pollution or dry nonconductive pollution that becomes conductive due to condensation occurs. For example, sheltered outdoor environment.
- **Pollution Degree 4:** The pollution generates persistent conductivity caused by conductive dust, rain, or snow. For example, outdoor areas.

Safety Class

Class 1 – Grounded Product

1.6 Care and Cleaning

Care

Do not store or leave the instrument where it may be exposed to direct sunlight for long periods of time.

Cleaning

Clean the instrument regularly according to its operating conditions.

1. Disconnect the instrument from all power sources.
2. Clean the external surfaces of the instrument with a soft cloth dampened with mild detergent or water. Avoid having any water or other objects into the chassis via the heat dissipation hole. When cleaning the LCD, take care to avoid scarifying it.



CAUTION

To avoid damage to the instrument, do not expose it to caustic liquids.



WARNING

To avoid short-circuit resulting from moisture or personal injuries, ensure that the instrument is completely dry before connecting it to the power supply.

1.7 Environmental Considerations

The following symbol indicates that this product complies with the WEEE Directive 2002/96/EC.



The equipment may contain substances that could be harmful to the environment or human health. To avoid the release of such substances into the environment and avoid harm to human health, we recommend you to recycle this product appropriately to ensure that most materials are reused or recycled properly. Please contact your local authorities for disposal or recycling information.

You can click on the following link <https://int.rigol.com/services/services/declaration> to download the latest version of the RoHS&WEEE certification file.

2 Document Overview

This manual gives you a quick overview of the front and rear panel, user interface as well as basic operation methods of DHO1000 series.

TIP

For the newest version of this manual, download it from RIGOL official website (<http://www.rigol.com>).

Publication Number

QGA32103-1110

Software Version

Software upgrade might change or add product features. Please acquire the latest version of the manual from RIGOL website or contact RIGOL to upgrade the software.

Format Conventions in this Manual

1. Key

The front panel key is denoted by the menu key icon. For example,  indicates the "DEFAULT" key.

2. Menu

The menu item is denoted by the format of "Menu Name (Bold) + Character Shading" in the manual. For example, **Setup** indicates the "Setup" sub-menu under the "Utility" function menu. You can click or tap **Setup** to access the "Setup" menu.

3. Operation Procedures

The next step of the operation is denoted by ">" in the manual. For example, 

> **Storage** indicates first clicking or tapping  and then clicking or tapping **Storage**.

4. The front/rear panel connector is denoted by "Brackets + Connector Name (Bold)", for example, **[AUX OUT]**.

Content Conventions in this Manual

DHO1000 series digital oscilloscope includes the following models. Unless otherwise specified, this manual takes the 4-channel model DHO1104 as an example to illustrate the basic operation methods of DHO1000 series.

Model	Max. Analog Bandwidth	Analog Channels
DHO1072	70 MHz	2

Model	Max. Analog Bandwidth	Analog Channels
DHO1074	70 MHz	4
DHO1102	100 MHz	2
DHO1104	100 MHz	4
DHO1202	200 MHz	2
DHO1204	200 MHz	4

3 General Inspection

1. Inspect the packaging

If the packaging has been damaged, do not dispose the damaged packaging or cushioning materials until the shipment has been checked for completeness and has passed both electrical and mechanical tests.

The consigner or carrier shall be liable for the damage to the instrument resulting from shipment. RIGOL would not be responsible for free maintenance/rework or replacement of the instrument.

2. Inspect the instrument

In case of any mechanical damage, missing parts, or failure in passing the electrical and mechanical tests, contact your RIGOL sales representative.

3. Check the accessories

Please check the accessories according to the packing lists. If the accessories are damaged or incomplete, please contact your RIGOL sales representative.

Recommended Calibration Interval

RIGOL suggests that the instrument should be calibrated every 18 months.

4 Product Overview

DHO1000 series digital oscilloscope is designed to meet the requirements for the design, debug, and test of the mainstream oscilloscope market. Adopting the brand-new chipset "Centaurus" developed by RIGOL, this series achieves a fast waveform capture rate of 1,500,000 wfms/s with the UltraAcquire mode, 100 Mpts memory depth, 12-bit resolution, all combined with excellent noise floor performance and vertical accuracy to meet your requirements for more accurate measurements.

4.1 Front Panel Overview

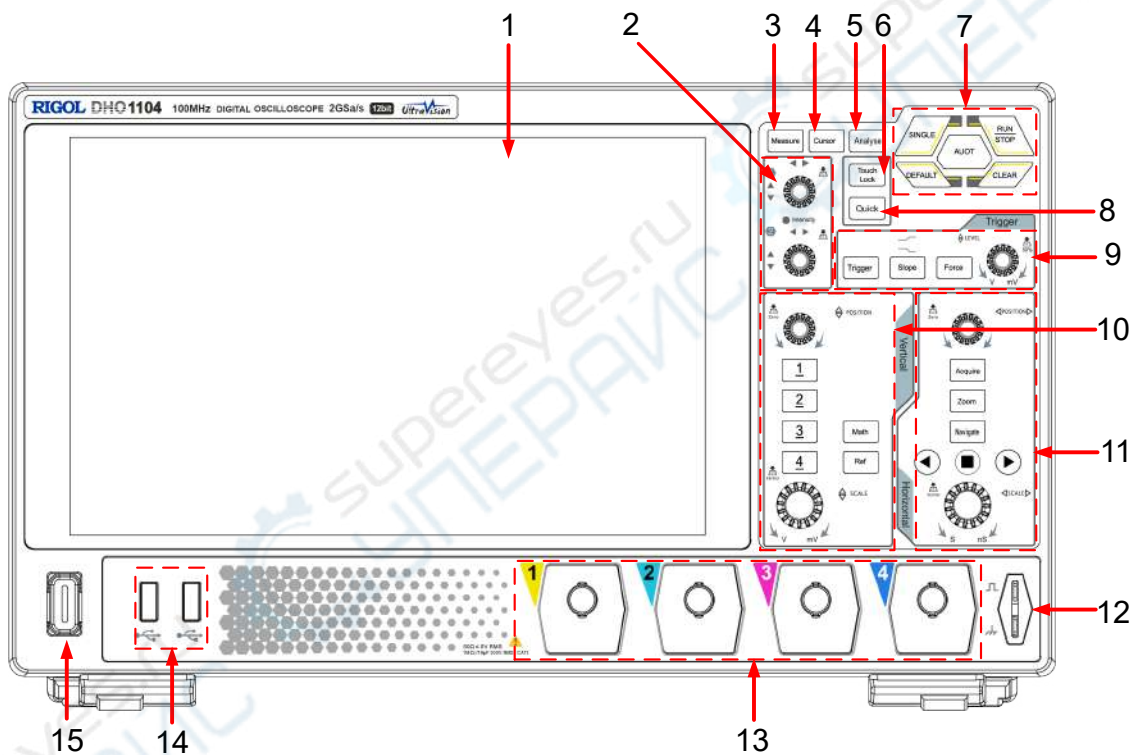

Figure 4.1 Front Panel (4-channel Model)

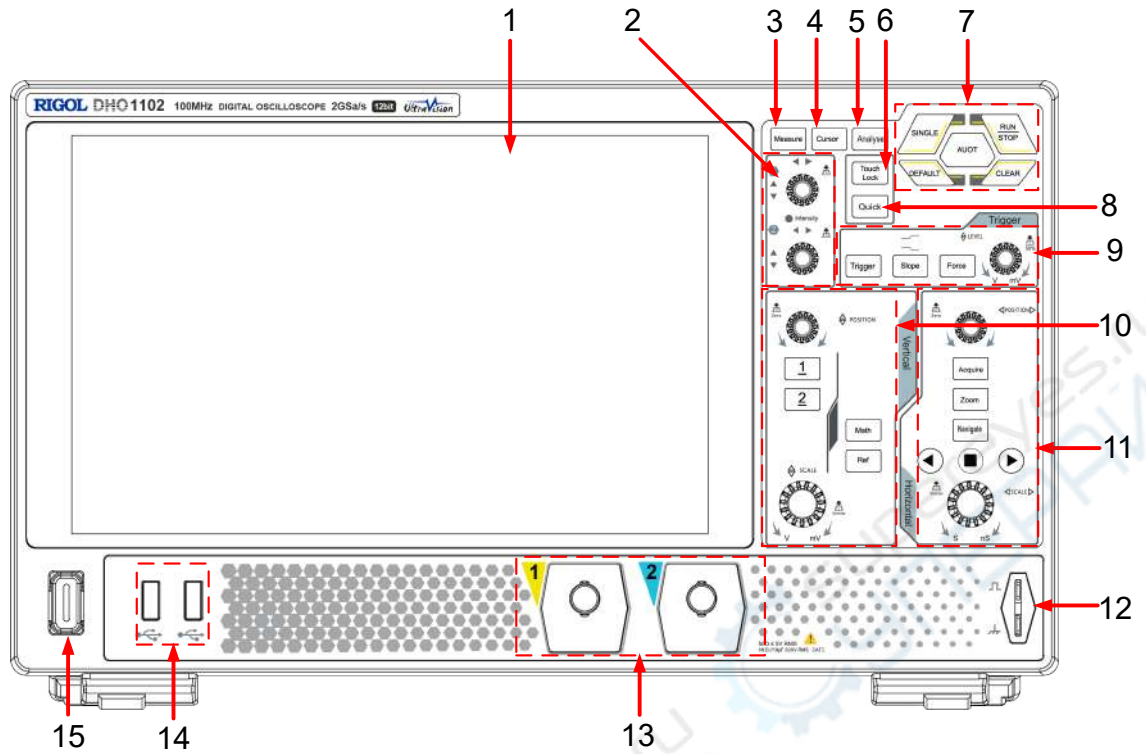

Figure 4.2 Front Panel (2-channel Model)

- | | | | |
|---|---|----|--|
| 1 | 10.1" Capacitive Touch Screen | 9 | Trigger Controls |
| 2 | Multipurpose Knobs | 10 | Vertical Controls |
| 3 | Measure Key | 11 | Horizontal Controls |
| 4 | Cursor Key | 12 | Probe Compensation Signal
Output Terminal/Ground Terminal |
| 5 | Analyse Key | 13 | Analog Channel Input Terminals |
| 6 | Touch Lock Key | 14 | USB HOST Port |
| 7 | Common Tools Keys | 15 | Power Switch |
| 8 | Quick Action Key (Self-defined
function) | | |

4.2 Rear Panel Overview

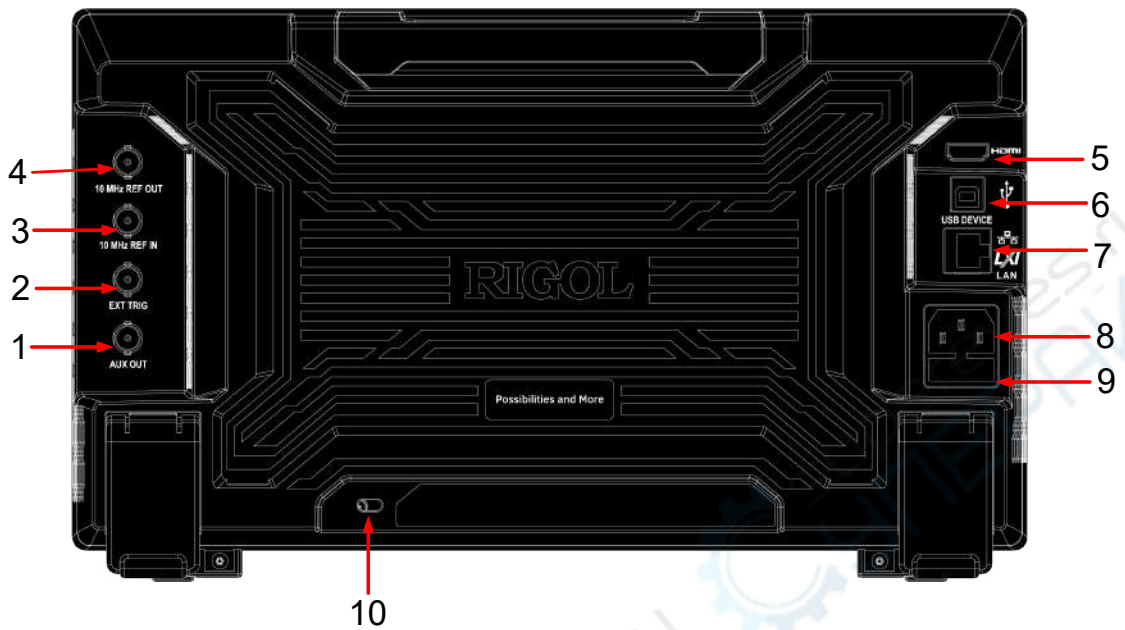

Figure 4.3 Rear Panel

- | | |
|----|---|
| 1 | Trigger Output Connector |
| 2 | External Trigger Input Connector |
| 3 | 10 MHz Reference Clock Input Connector |
| 4 | 10 MHz Reference Clock Output Connector |
| 5 | HDMI Connector |
| 6 | USB DEVICE Port |
| 7 | LAN Port |
| 8 | AC Power Cord Connector |
| 9 | Fuse |
| 10 | Security Lock Hole |

4.3 User Interface Overview

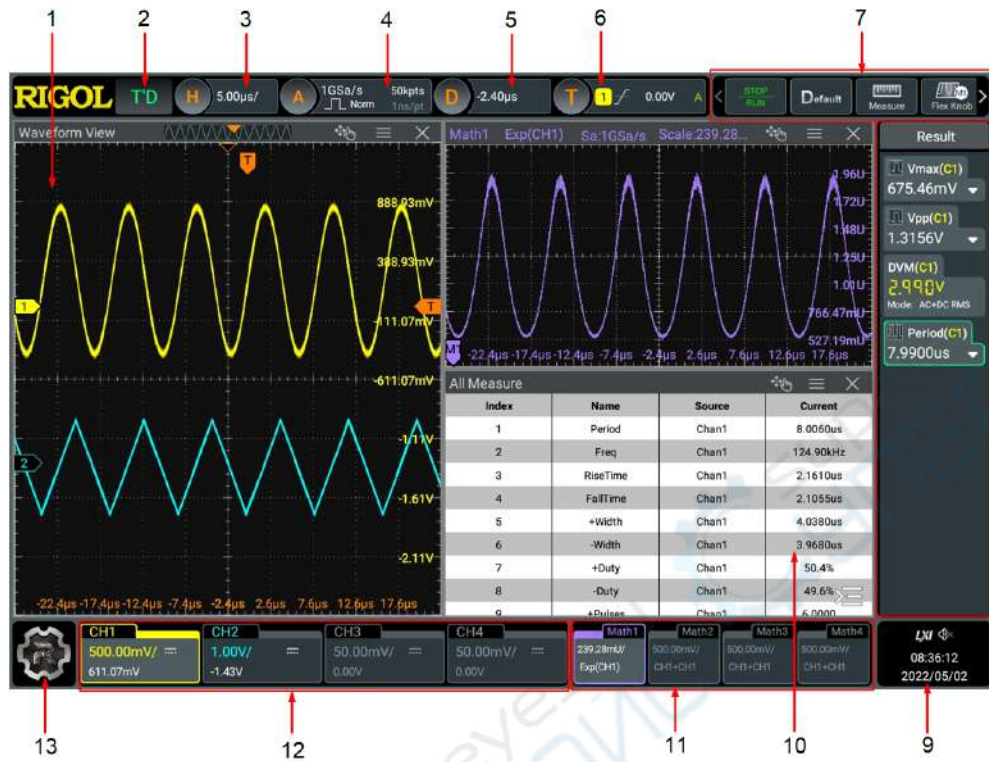

Figure 4.4 User Interface

- | | | | |
|---|----------------------------------|----|--------------------------|
| 1 | Waveform View | 8 | Result Sidebar |
| 2 | Run State Label | 9 | Notification Area |
| 3 | Horizontal Timebase Label | 10 | Split-screen Display |
| 4 | Sample Rate & Memory Depth Label | 11 | Math Labels |
| 5 | Horizontal Delay Label | 12 | Channel Labels |
| 6 | Trigger Label | 13 | Function Navigation Icon |
| 7 | Function Toolbar | | |

5 To Prepare for Use

5.1 Tilting the Oscilloscope for Easier Viewing

Flip out the tabs under the oscilloscope's rear feet to tilt the oscilloscope to stabilize it for easier operation and viewing. Flip in the tabs for storage or transporting when not using the instrument. Please see the figure below.

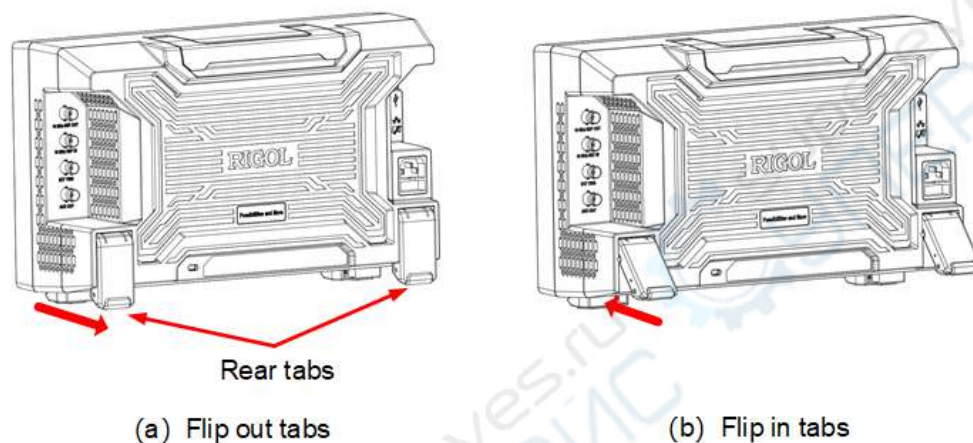
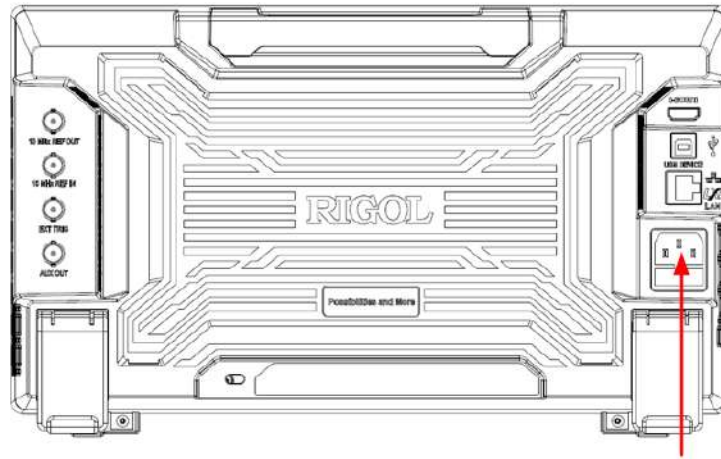

Figure 5.1 Flipping in/out Tabs

5.2 Connecting to Power

The power requirements of the oscilloscope are 100-240 V, 50-60 Hz. Please use the power cord provided in the accessories to connect the oscilloscope to the AC power source, as shown in the figure below.



Power Cord Connector





Figure 5.2 Connecting to Power

**WARNING**

To avoid electric shock, ensure that the instrument is correctly grounded.

5.3 Turn-on Checkout

After the instrument is connected to the power source, press the power switch  at the lower-left corner of the front panel to power on the instrument. During the start-up process, the instrument performs a series of self-tests. After the self-test, the splash screen is displayed.

- **Restart:** Click or tap  > **Restart**. Then a prompt message "Are you sure to reboot?" is displayed. Click or tap **OK** to restart the instrument.
- **Shutdown:**
 - Click or tap  > **Shutdown**. Then a prompt message "Are you sure to shutdown?" is displayed. Click or tap **OK** to shut down the instrument.
 - Press the power switch  and a prompt message "Are you sure to shutdown?" is displayed. Click or tap **OK** to shut down the instrument.
 - Press  twice to directly shut down the instrument.
 - Press  for three seconds to directly shut down the instrument.

**TIP**

You can also click or tap  > **Utility** > **Setup** and select "Switch On" in "Power Status" item. In this way, the instrument powers on once connected to power.

5.4 Setting the System Language

This oscilloscope supports multiple languages. You can click or tap  > **Utility** > **Setup** > **Language** to select the system language.

5.5 Connecting Probes

RIGOL provides passive probes for DHO1000 series. For specific probe models, please refer to *DHO1000 series Data Sheet*. For detailed technical information of the probes, please refer to the corresponding Probe User Guide.

Connect the Passive Probe

1. Connect the BNC terminal of the probe to an analog channel input terminal of the oscilloscope on the front panel as shown in the figure below.
2. Connect the ground alligator clip or spring of the probe to the circuit ground terminal, and then connect the probe tip to the circuit point to be tested.

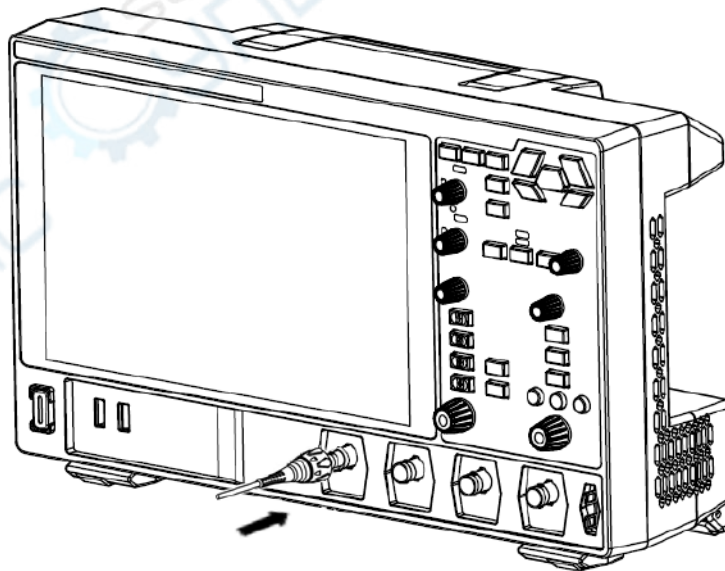



Figure 5.3 Connecting the Passive Probe

After you connect the passive probe, check the probe function and probe compensation adjustment before making measurements. For details, please refer to *Function Inspection* and *Probe Compensation*.

5.6 Function Inspection

1. Press the front-panel  and a prompt message "Restore default settings?" is displayed. Click or tap **OK** to restore the instrument to its factory default settings.
2. Connect the ground alligator clip of the probe to the "Ground Terminal" as shown in *Figure 5.4*.
3. Use the probe to connect the input terminal of CH1 and the "Compensation Signal Output Terminal" of the probe, as shown in *Figure 5.4*.

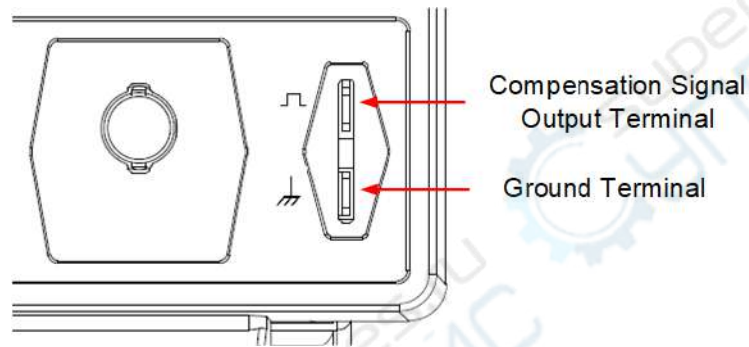

Figure 5.4 Using the Compensation Signal

4. Set the probe ratio based on the attenuation of the probe, and then click or tap  > **Auto**.
5. Observe the waveform on the display. In normal condition, you should see a square waveform similar to the waveform shown in the figure below.



Figure 5.5 Square Waveform Signal

6. Test the other channels in the same way. If you see the waveform, but the square wave is not shaped correctly as shown above, perform the procedure described in *Probe Compensation*. If you do not see the waveform, perform these steps again.



WARNING

To avoid electric shock when using the probe, please make sure that the insulated wire of the probe is in good condition. Do not touch the metallic part of the probe when the probe is connected to high voltage source.

5.7 Probe Compensation

When used for the first time, the oscilloscope probe must be compensated to match the input characteristics of the oscilloscope channel to which it is connected. A non-compensated or poorly compensated probes can introduce measurement inaccuracy or errors. The compensation procedure is as follows:

1. Perform step 1, 2, 3, and 4 in *Function Inspection*.
2. Check the displayed waveforms and compare them with waveforms shown in the figure below.



Figure 5.6 Probe Compensation

3. Use the probe compensation adjustment tool provided in the accessories to adjust the low-frequency compensation adjustment hole on the probe until the displayed waveform is consistent with the "Perfectly compensated" waveform shown in the figure above.

6 Touch Screen Gestures

The instrument's large capacitive touch screen makes operation and configuration easy and flexible. The highly sensitive user interface designed for touch has a strong waveform display capability, bringing an extraordinary user experience. The actions supported by the touch screen controls include tapping, pinching&stretching, as well as dragging.

6.1 Tap

Use one finger to tap the symbol or characters on the screen slightly, as shown in *Figure 6.1* . With the Tap gesture, you can perform the following operation:

- Tap the menu displayed on the screen to operate on the menu.
- Tap the function navigation icon  at the lower-left corner of the touch screen to enable the function navigation.
- Tap the displayed numeric keypad to set the parameters.
- Tap the virtual keypad to set the label name and the filename.
- Tap the close button at the upper-right corner of the message box to close the prompt window.
- Tap other windows on the touch screen and operate on the windows.



Figure 6.1 Tap Gestures

6.2 Drag

Use one finger to select the object, and then drag the object to a destination place, as shown in the figure below. With the drag gesture, you can perform the following operation:

- Drag the waveform to change its position or scale.
- Drag the window controls to change the position of the window (e.g. numeric keypad).
- Drag the cursor to move the cursor.
- Drag the trigger cursor to change the trigger level.
- In multi-window display, drag one of the displayed windows to change its position on the display.



Figure 6.2 Drag Gesture

6.3 Pinch&Stretch

Pinch or stretch two points on the screen with two fingers to zoom in or out the waveform. To zoom in the waveform, first pinch the two fingers and then stretch the fingers; to zoom out the waveform, first stretch the two fingers, and then pinch the fingers together, as shown in the figure below. With the pinch&stretch gesture, you can perform the following operation:

- Pinching&stretching in the horizontal direction can adjust the horizontal time base of the waveform.
- Pinching&stretching in the vertical direction can adjust the vertical scale of the waveform.



Figure 6.3 Pinch&Stretch Gesture

supereyes.ru
СУПЕРАЙС
supereyes.ru
СУПЕРАЙС
supereyes.ru
СУПЕРАЙС

7 Accessing the Built-in Help System

The built-in help system provides instructions for all the front-panel keys and their corresponding menu keys. Click or tap  > **Help** to access the "Help" menu.

After that, you can get its help information by clicking on or tapping the link for the desired item.



8 Parameter Setting Method

For this instrument, you can use the knobs and touch screen to set parameters. The common parameter setting methods are as follows:

- **Method 1:** Some parameters can be adjusted by rotating the front-panel knobs.
- **Method 2:** Click or tap the input field of a specified parameter, then a virtual keypad is displayed. Complete the parameter setting with the keypad.

Input a Value

When setting or modifying a parameter, you can input an appropriate value with the numeric keypad.

- Input a value or unit in the keypad using the touch screen.
- You can also rotate the multipurpose knob (1 or 2) to move the cursor and select the desired value and unit. Then press the knob to input the selected value or unit.



Figure 8.1 Numeric Keypad

After you input all the values and select the desired units, the numeric keypad is turned off automatically. This indicates that you have completed parameter setting. Besides, after you have input the values, you can also press "OK" directly to close the numeric keypad. At this time, the unit of the parameter is the default unit. In the numeric keypad, you can perform the following operations:

- Delete the parameter value that has been input;

- Set the parameter value to a maximum or minimum value;
- Set the parameter to a default value.
- Clear the parameter input field.



9 Replacing the Fuse

If you need to replace the fuse, please use the correct fuse (AC 250 V, T3.15 A; 5.2 mm×20 mm) and follow the steps shown below (see [Figure 9.1](#)).

1. Power off the instrument and remove the power cord.
2. Insert a small straight screwdriver into the slot at the power socket and pry out the fuse holder gently.
3. Remove the fuse.
4. Insert the proper fuse into the fuse holder.
5. Re-insert the fuse holder into the power socket.

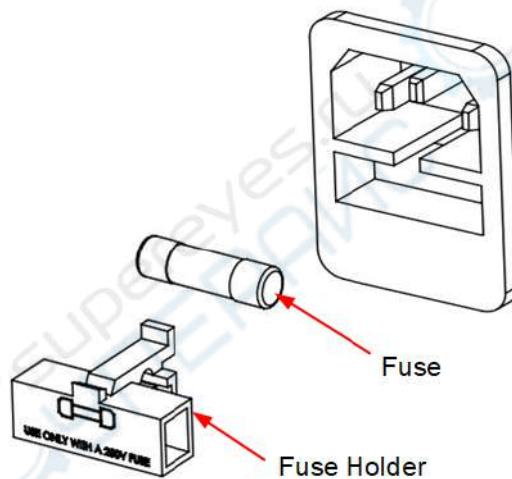

Figure 9.1 Replacing the Fuse



WARNING

To avoid electric shock, please make sure that the instrument is powered off and disconnected from the power before replacing the fuse. Also, please make sure the fuse is consistent with the required fuse rating.

10 Remote Control

The instrument can be remotely controlled by the following three methods:

- **User-defined Programming**

Users can program and control the instrument by using the SCPI (Standard Commands for Programmable Instruments) commands. For details about the SCPI commands and programming, refer to *Programming Guide*.

- **PC Software**

Users can use the PC software to send commands to control the instrument remotely. RIGOL Ultra Sigma is recommended. You can download the software from RIGOL official website (<http://www.rigol.com>).

Operation Procedures:

- Set up communication between the instrument and PC.
- Run Ultra Sigma and search for the instrument resource.
- Open the remote command control panel to send commands.

- **Web Control**

This instrument supports Web Control. Connect the instrument to the network, then input the IP address of the instrument into the address bar of the browser of your computer. The web control interface is displayed. Click Web Control to enter the web control page. Then you can view the display of the real-time interface of the instrument. Through the Web Control method, you can migrate the device control to the control terminals (e.g. PC, Mobile, iPad, and other smart terminals) to realize remote control of the instrument. When you first log in to the Web Control, the user name is "admin" and password is "rigol".

This instrument can be connected to the PC via the USB, LAN, or GPIB interface to set up communication and realize remote control through the PC. The remote control can be realized by using SCPI (Standard Commands for Programmable Instruments) commands.

CAUTION

Before connecting the communication cable, please turn off the instrument to avoid causing damage to the communication interfaces.



11 More Product Information

1. Obtain the Device Information

Click or tap  > **Utility** > **About** to obtain the information of the instrument, such as the model, serial number, and firmware version number.

2. View the Option Information and Install the Option

The instrument is installed with the trial versions of the options before leaving factory. The trial time starts from the time when you power on the instrument for the first time, and the trial time is about 2,160 minutes. Open the "Utility" menu, and then click or tap **Option** to view the options currently installed on the oscilloscope and their information. For details, refer to descriptions in this series User Guide.

For more information about the instrument, refer to the relevant manuals by logging in to the official website of RIGOL (<http://www.rigol.com>) to download them.

- *DHO1000 User Guide*: introduces the functions of the instrument and the operation methods, remote control methods, possible failures and solutions in using the instrument, specifications, and order information.
- *DHO1000 Programming Guide*: provides detailed descriptions of SCPI commands and programming examples of the instrument.
- *DHO1000 Data Sheet*: provides the key features and technical specifications of the instrument.