

BLF574

HF / VHF power LDMOS transistor

Rev. 02 — 24 February 2009

Product data sheet

1. Product profile

1.1 General description

A 500 W to 600 W LDMOS power transistor for broadcast applications and industrial applications in the HF to 500 MHz band.

Table 1. Application information

Mode of operation	f (MHz)	V _{DS} (V)	P _L (W)	G _p (dB)	η _D (%)
CW	225	50	500	26.5	70
	108	50	600	27.5	73

CAUTION



This device is sensitive to ElectroStatic Discharge (ESD). Therefore care should be taken during transport and handling.

1.2 Features

- Typical CW performance at frequency of 225 MHz, a supply voltage of 50 V and an I_{Dq} of 1000 mA:
 - ◆ Average output power = 500 W
 - ◆ Power gain = 26.5 dB
 - ◆ Efficiency = 70 %
- Easy power control
- Integrated ESD protection
- Excellent ruggedness
- High efficiency
- Excellent thermal stability
- Designed for broadband operation (10 MHz to 500 MHz)
- Compliant to Directive 2002/95/EC, regarding Restriction of Hazardous Substances (RoHS)

1.3 Applications

- Industrial, scientific and medical applications
- Broadcast transmitter applications

2. Pinning information

Table 2. Pinning

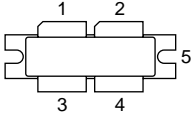
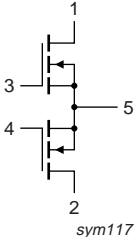
Pin	Description	Simplified outline	Graphic symbol
1	drain1		 sym117
2	drain2		
3	gate1		
4	gate2		
5	source		

[1] Connected to flange.

3. Ordering information

Table 3. Ordering information

Type number	Package		Version
	Name	Description	
BLF574	-	flanged balanced LDMOST ceramic package; 2 mounting holes; 4 leads	SOT539A

4. Limiting values

Table 4. Limiting values

In accordance with the Absolute Maximum Rating System (IEC 60134).

Symbol	Parameter	Conditions	Min	Max	Unit
V_{DS}	drain-source voltage		-	110	V
V_{GS}	gate-source voltage		-0.5	+11	V
I_D	drain current		-	56	A
T_{stg}	storage temperature		-65	+150	°C
T_j	junction temperature		-	225	°C

5. Thermal characteristics

Table 5. Thermal characteristics

Symbol	Parameter	Conditions	Typ	Unit
$R_{th(j-c)}$	thermal resistance from junction to case	$T_{case} = 80\text{ °C}; P_L = 400\text{ W}$	0.23	K/W

[1] $R_{th(j-c)}$ is measured under RF conditions.

6. Characteristics

Table 6. DC characteristics

$T_j = 25\text{ }^\circ\text{C}$; per section unless otherwise specified.

Symbol	Parameter	Conditions	Min	Typ	Max	Unit
$V_{(BR)DSS}$	drain-source breakdown voltage	$V_{GS} = 0\text{ V}; I_D = 2.5\text{ mA}$	110	-	-	V
$V_{GS(th)}$	gate-source threshold voltage	$V_{DS} = 10\text{ V}; I_D = 250\text{ mA}$	1.25	1.7	2.25	V
V_{GSq}	gate-source quiescent voltage	$V_{DS} = 50\text{ V}; I_D = 500\text{ mA}$	1.35	1.85	2.35	V
I_{DSS}	drain leakage current	$V_{GS} = 0\text{ V}; V_{DS} = 50\text{ V}$	-	-	2.8	μA
I_{DSX}	drain cut-off current	$V_{GS} = V_{GS(th)} + 3.75\text{ V};$ $V_{DS} = 10\text{ V}$	29	37.5	-	A
I_{GSS}	gate leakage current	$V_{GS} = 11\text{ V}; V_{DS} = 0\text{ V}$	-	-	280	nA
g_{fs}	forward transconductance	$V_{DS} = 10\text{ V}; I_D = 12.5\text{ A}$	-	17	-	S
$R_{DS(on)}$	drain-source on-state resistance	$V_{GS} = V_{GS(th)} + 3.75\text{ V};$ $I_D = 8.33\text{ A}$	-	0.14	-	Ω
C_{rs}	feedback capacitance	$V_{GS} = 0\text{ V}; V_{DS} = 50\text{ V};$ $f = 1\text{ MHz}$	-	1.5	-	pF
C_{iss}	input capacitance	$V_{GS} = 0\text{ V}; V_{DS} = 50\text{ V};$ $f = 1\text{ MHz}$	-	204	-	pF
C_{oss}	output capacitance	$V_{GS} = 0\text{ V}; V_{DS} = 50\text{ V};$ $f = 1\text{ MHz}$	-	72	-	pF

Table 7. RF characteristics

Mode of operation: CW; $f = 225\text{ MHz}$; RF performance at $V_{DS} = 50\text{ V}; I_{Dq} = 1000\text{ mA}$ for total device; $T_{case} = 25\text{ }^\circ\text{C}$; unless otherwise specified; in a class-AB production test circuit.

Symbol	Parameter	Conditions	Min	Typ	Max	Unit
G_p	power gain	$P_L = 400\text{ W}$	25	26.5	28	dB
RL_{in}	input return loss	$P_L = 400\text{ W}$	13	20	-	dB
η_D	drain efficiency	$P_L = 400\text{ W}$	66	70	-	%

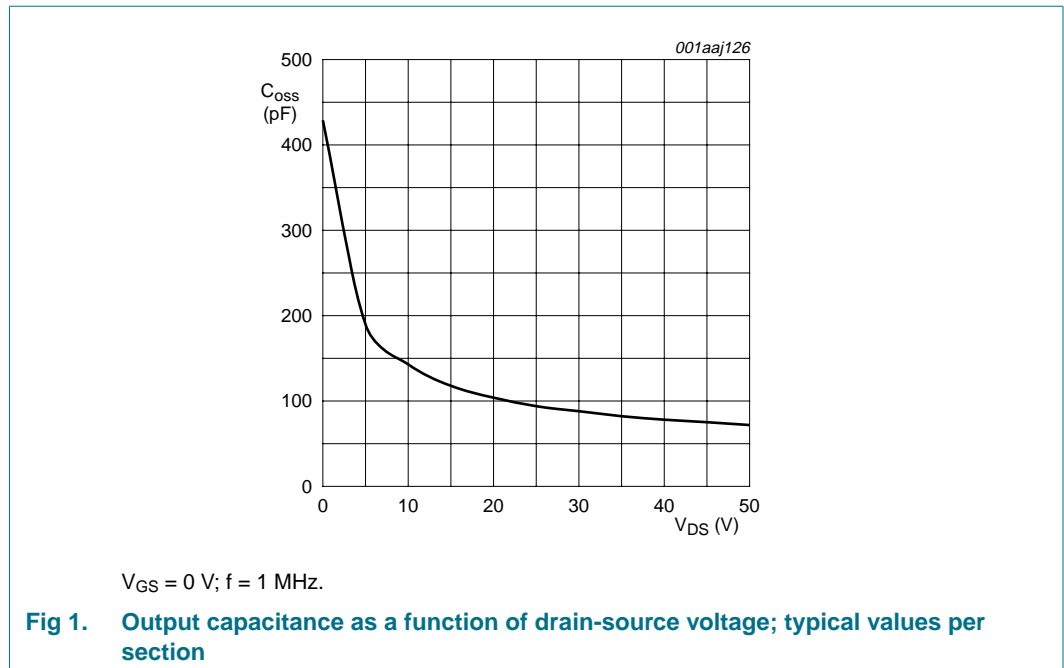

6.1 Ruggedness in class-AB operation

The BLF574 is capable of withstanding a load mismatch corresponding to $V_{SWR} = 13 : 1$ through all phases under the following conditions: $V_{DS} = 50$ V; $I_{Dq} = 1000$ mA; $P_L = 400$ W; $f = 225$ MHz.

7. Application information

7.1 RF performance

RF performance in a 500 W application circuit at 225 MHz.

7.1.1 1-Tone CW

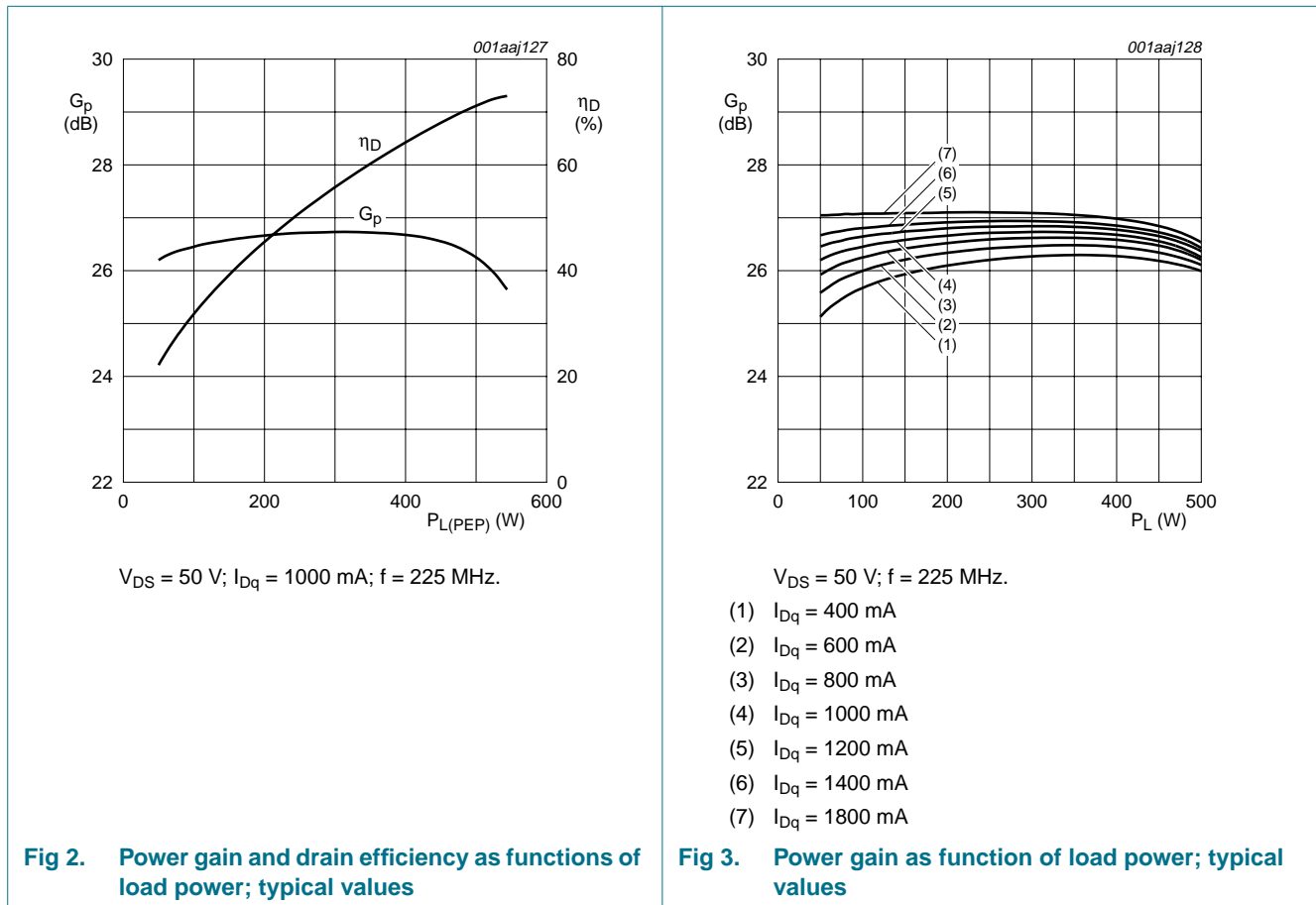

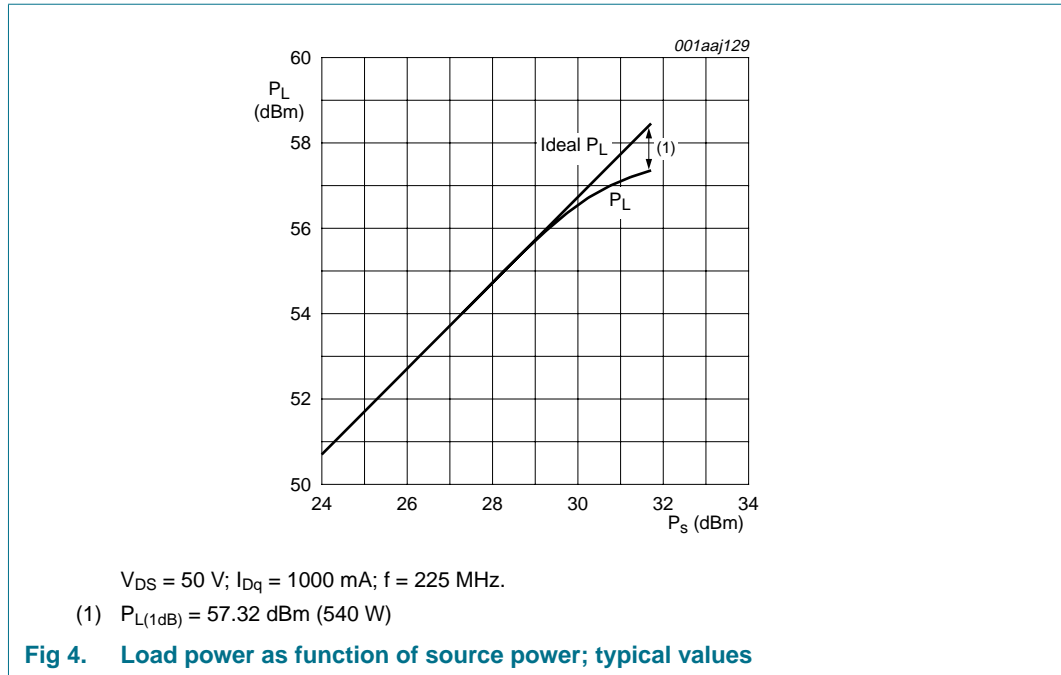

7.1.2 2-Tone CW

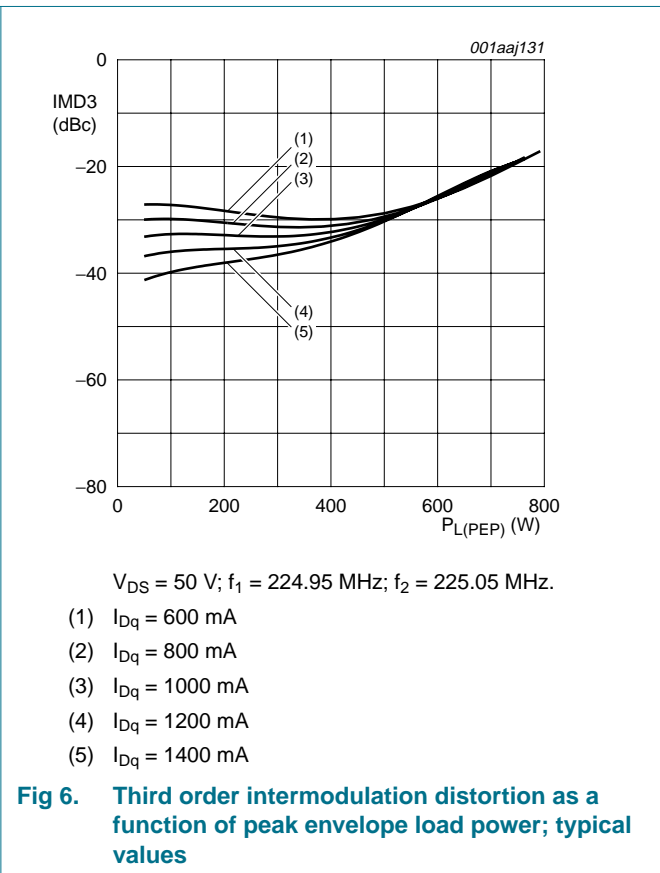
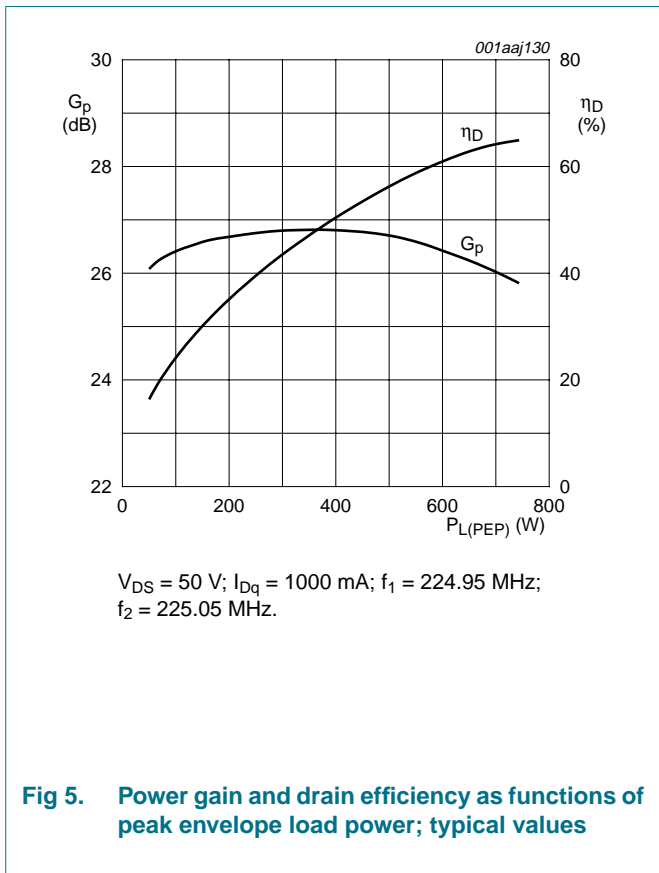

7.1.3 Application circuit

Table 8. List of components

For application circuit, see [Figure 7](#).

Printed-Circuit Board (PCB): Rogers 5880; $\epsilon_r = 2.2$ F/m; height = 0.79 mm; Cu (top/bottom metallization); thickness copper plating = 35 μ m.

Component	Description	Value	Remarks
C1, C2, C23, C24	multilayer ceramic chip capacitor	100 pF	[1]
C3	multilayer ceramic chip capacitor	24 pF	[1]
C4, C5	multilayer ceramic chip capacitor	39 pF	[1]
C6, C9	multilayer ceramic chip capacitor	4.7 μ F	TDK4532X7R1E475Mt020U
C7, C8, C10, C11	multilayer ceramic chip capacitor	1 nF	[1]
C12, C16	electrolytic capacitor	220 μ F; 63 V	
C13, C15	multilayer ceramic chip capacitor	62 pF	[1]
C14	multilayer ceramic chip capacitor	15 pF	[1]
C17, C19	multilayer ceramic chip capacitor	47 pF	[1]
C18	multilayer ceramic chip capacitor	33 pF	[1]
C20, C22	multilayer ceramic chip capacitor	10 pF	[1]
C21	multilayer ceramic chip capacitor	18 pF	[1]
L1, L2, L3, L4	3 turns 1 mm copper wire	D = 3 mm; length = 3 mm	
L5, L6	stripline	-	(L \times W) 125 mm \times 7 mm
L7, L8, L9, L10	stripline	-	(L \times W) 8 mm \times 15 mm
L11, L12	stripline	-	(L \times W) 132 mm \times 7 mm
R1, R2	metal film resistor	10 Ω ; 0.6 W	
R3, R4	metal film resistor	3 Ω ; 0.6 W	
T1, T2, T3, T4	semi rigid coax	50 Ω ; 120 mm	EZ-141-AL-TP-M17

[1] American Technical Ceramics type 100B or capacitor of same quality.

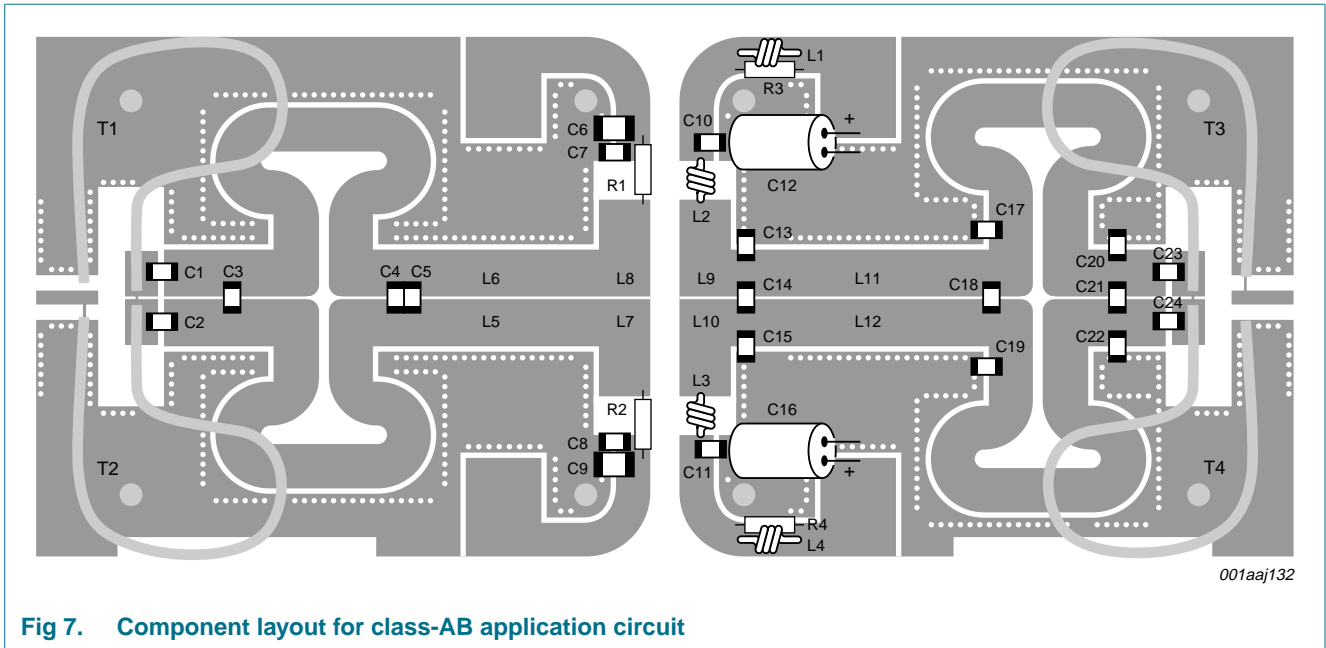
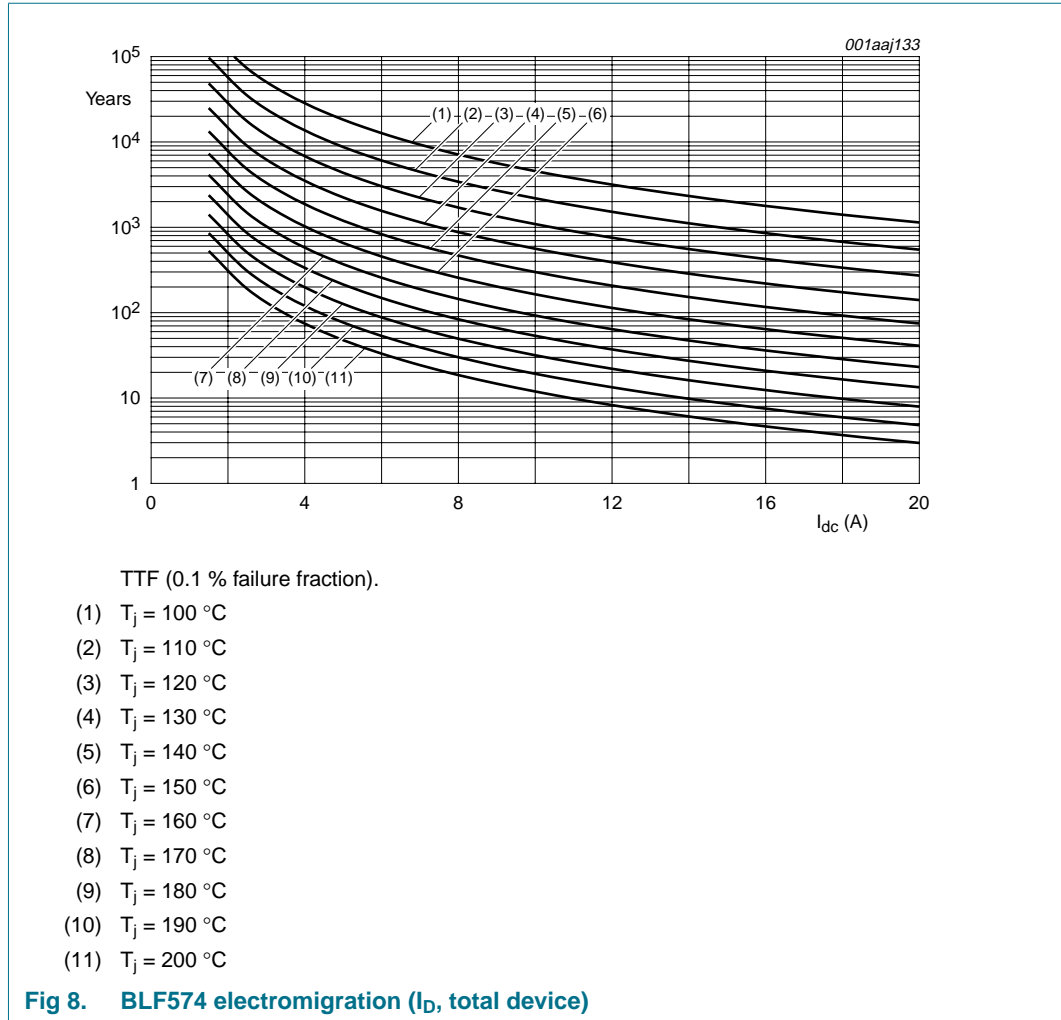

Fig 7. Component layout for class-AB application circuit

7.2 Reliability



8. Test information

8.1 Impedance information

Table 9. Typical impedance

Simulated Z_S and Z_L test circuit impedances.

f	Z_S	Z_L
MHz	Ω	Ω
225	$3.2 + j2.5$	$7.5 + j4.0$

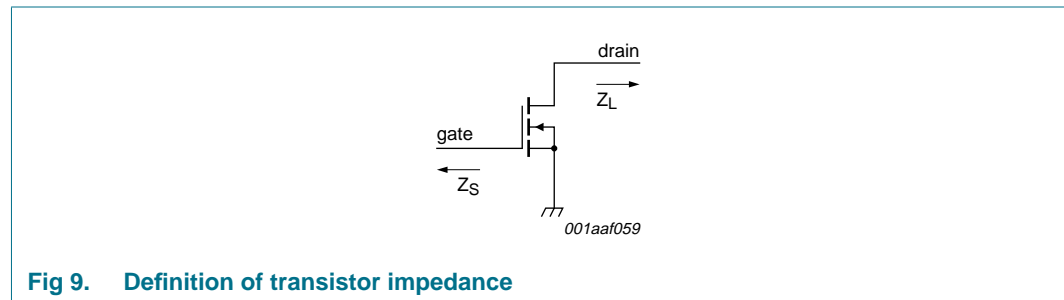
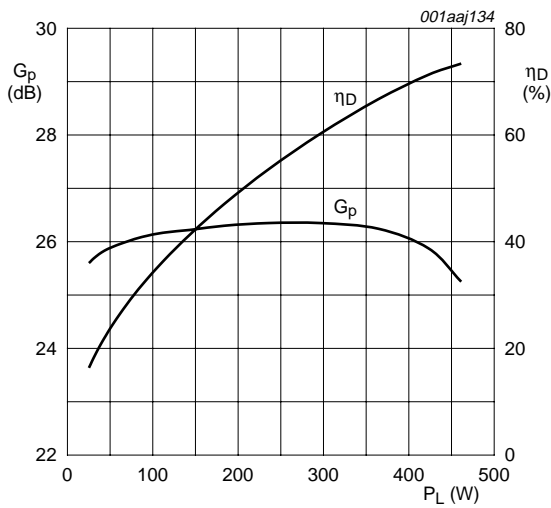

Fig 9. Definition of transistor impedance

8.2 RF performance

The following figures are measured in a class-AB production test circuit.

8.2.1 1-Tone CW



$V_{DS} = 50\text{ V}$; $I_{Dq} = 1000\text{ mA}$; $f = 225\text{ MHz}$.

Fig 10. Power gain and drain efficiency as functions of load power; typical values

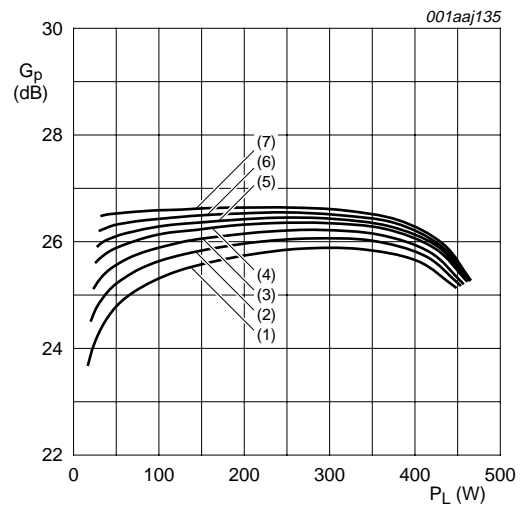

$V_{DS} = 50\text{ V}$; $f = 225\text{ MHz}$.

- (1) $I_{Dq} = 400\text{ mA}$
- (2) $I_{Dq} = 600\text{ mA}$
- (3) $I_{Dq} = 800\text{ mA}$
- (4) $I_{Dq} = 1000\text{ mA}$
- (5) $I_{Dq} = 1200\text{ mA}$
- (6) $I_{Dq} = 1400\text{ mA}$
- (7) $I_{Dq} = 1800\text{ mA}$

Fig 11. Power gain as function of load power; typical values

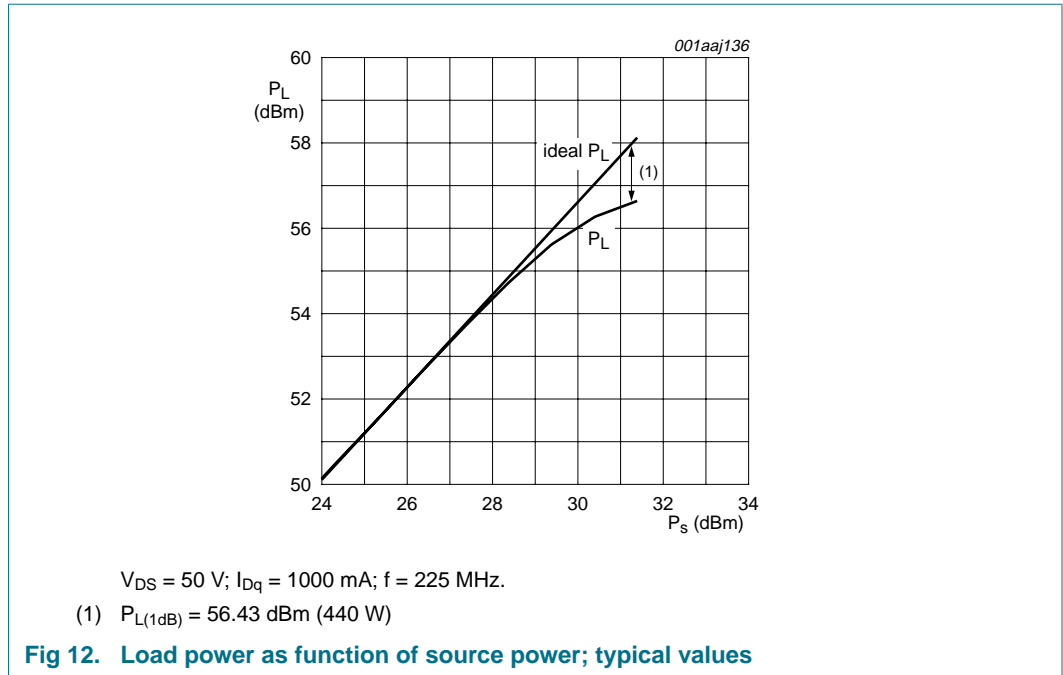

8.2.2 2-Tone CW

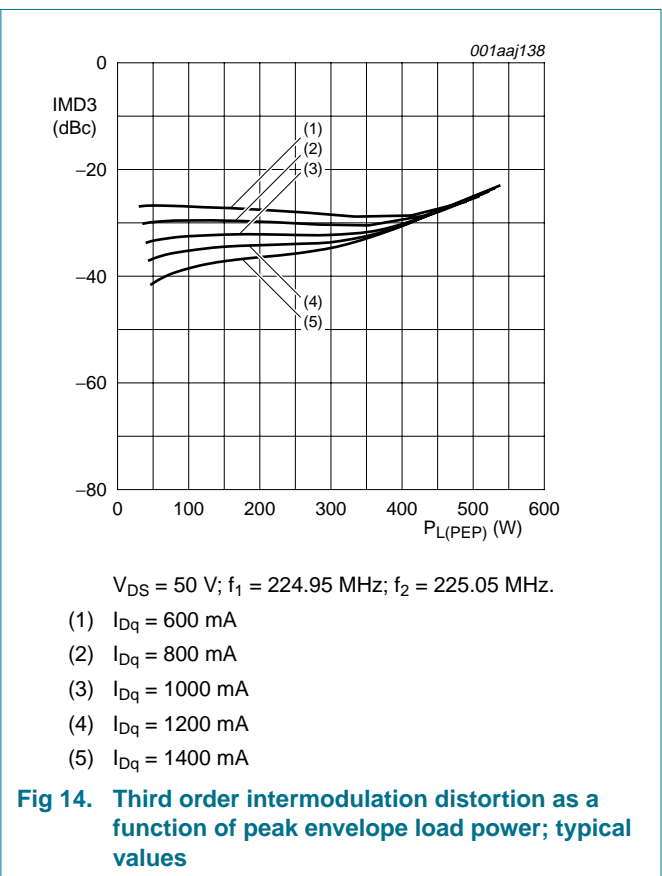
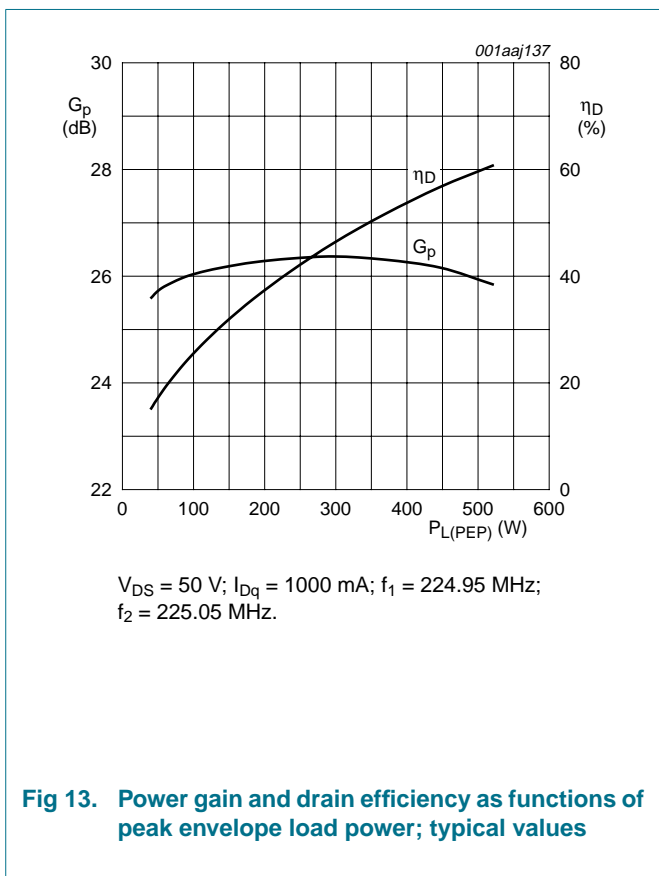

8.2.3 Test circuit

Table 10. List of components

For production test circuit, see [Figure 15](#) and [Figure 16](#).

Printed-Circuit Board (PCB): Rogers 5880; $\epsilon_r = 2.2$ F/m; height = 0.79 mm; Cu (top/bottom metallization); thickness copper plating = 35 μm .

Component	Description	Value	Remarks
C1, C2, C20, C21	multilayer ceramic chip capacitor	100 pF	[1]
C3	multilayer ceramic chip capacitor	24 pF	[1]
C4, C5	multilayer ceramic chip capacitor	39 pF	[1]
C6, C7, C10, C11	multilayer ceramic chip capacitor	1 nF	[1]
C8, C9	multilayer ceramic chip capacitor	4.7 μF	[1] TDK4532X7R1E475Mt020U
C12, C13	electrolytic capacitor	220 μF ; 63 V	
C14, C15	multilayer ceramic chip capacitor	47 pF	[1]
C16	multilayer ceramic chip capacitor	33 pF	[1]
C17	multilayer ceramic chip capacitor	18 pF	[1]
C18, C19	multilayer ceramic chip capacitor	10 pF	[1]
C22	multilayer ceramic chip capacitor	15 pF	[1]
C23, C24	multilayer ceramic chip capacitor	62 pF	[1]
L1, L2, L3, L4	3 turns 1 mm copper wire	D = 3 mm; length = 2 mm	
L5, L6	stripline	-	(L \times W) 125 mm \times 7 mm
L7, L8, L9, L10	stripline	-	(L \times W) 8 mm \times 15 mm
L11, L12	stripline	-	(L \times W) 132 mm \times 7 mm
R1, R2	metal film resistor	10 Ω ; 0.6 W	
R3, R4	metal film resistor	3 Ω ; 0.6 W	
T1, T2, T3, T4	semi rigid coax	50 Ω ; 120 mm	EZ-141-AL-TP-M17

[1] American Technical Ceramics type 100B or capacitor of same quality.

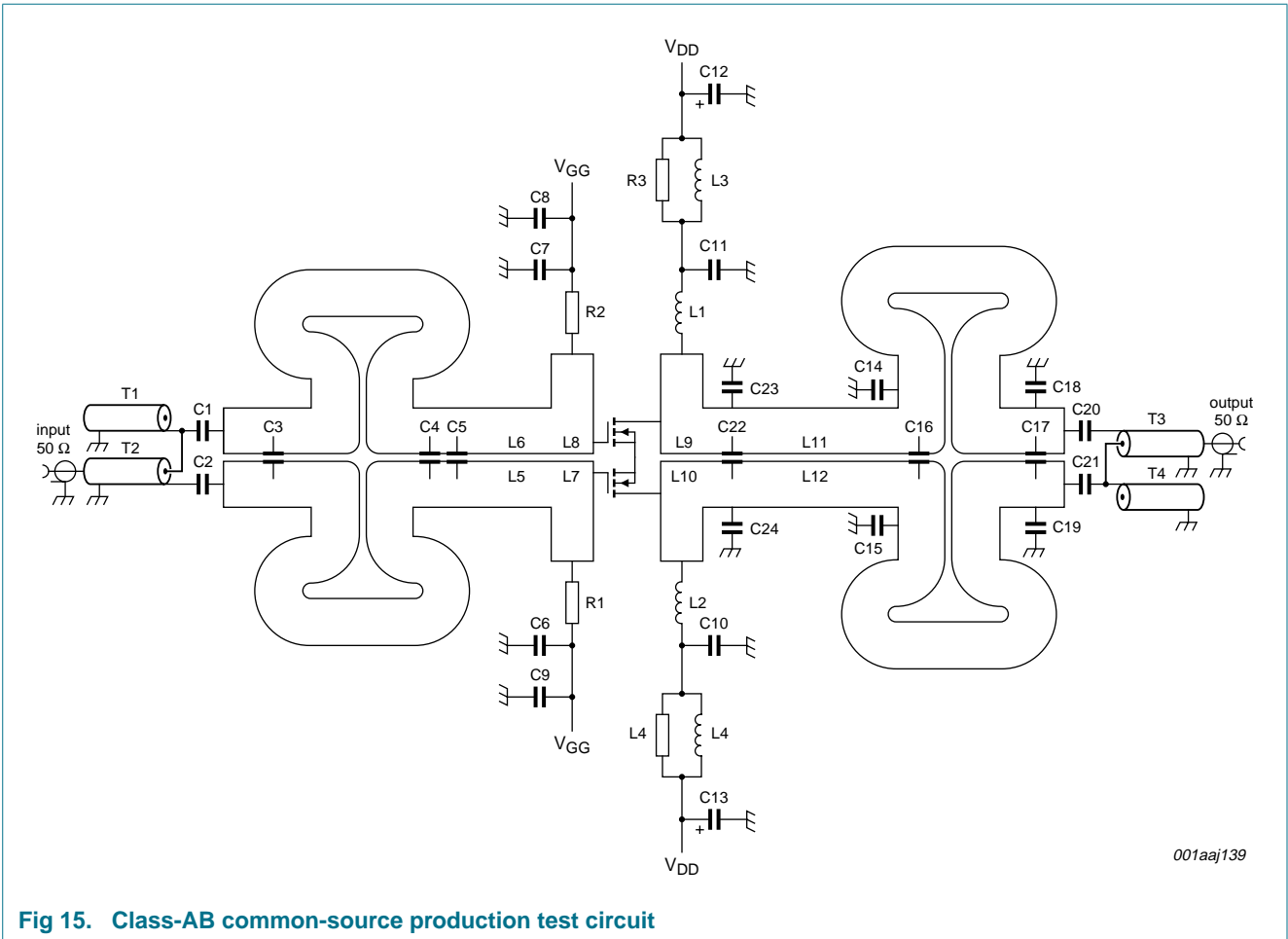

Fig 15. Class-AB common-source production test circuit

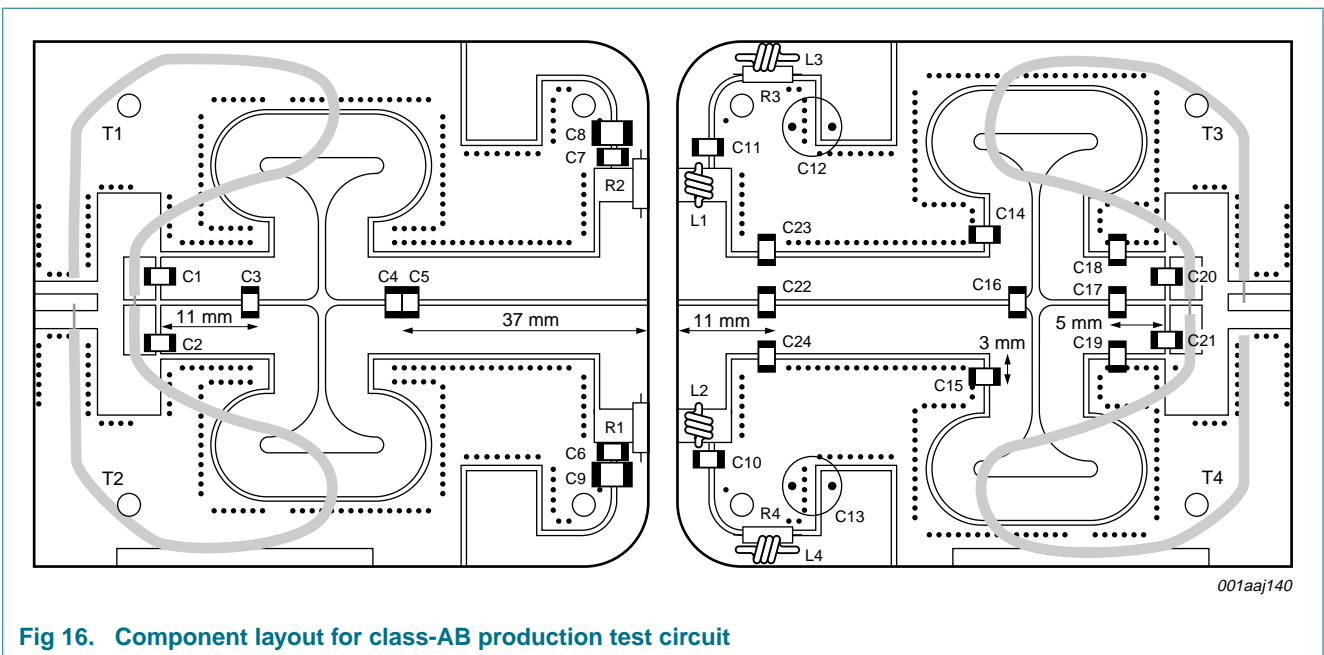

Fig 16. Component layout for class-AB production test circuit

9. Package outline

Flanged balanced LDMOST ceramic package; 2 mounting holes; 4 leads

SOT539A

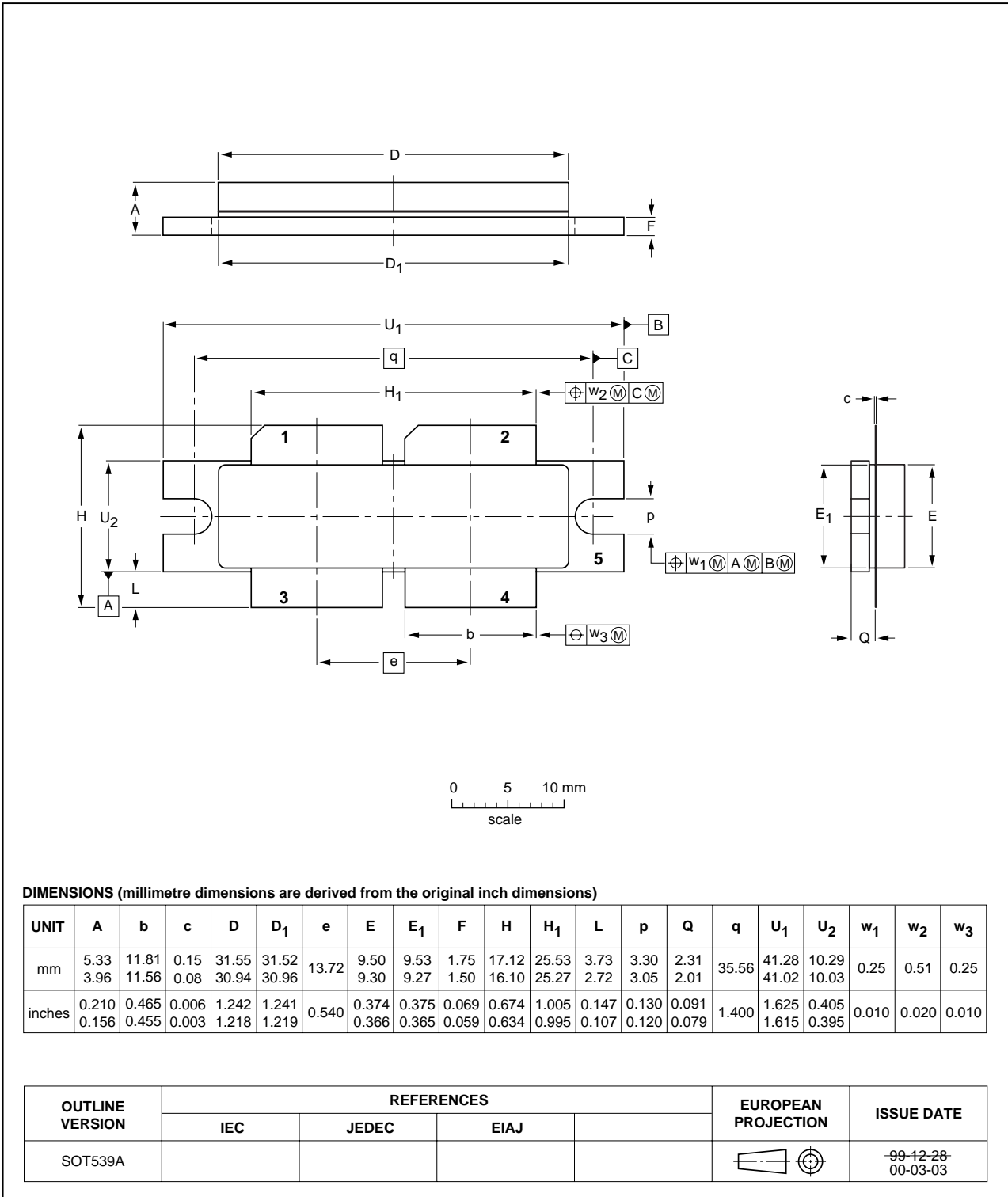

Fig 17. Package outline SOT539A

10. Abbreviations

Table 11. Abbreviations

Acronym	Description
CW	Continuous Wave
EDGE	Enhanced Data rates for GSM Evolution
GSM	Global System for Mobile communications
HF	High Frequency
LDMOS	Laterally Diffused Metal-Oxide Semiconductor
LDMOST	Laterally Diffused Metal-Oxide Semiconductor Transistor
RF	Radio Frequency
TTF	Time To Failure
VHF	Very High Frequency
VSWR	Voltage Standing-Wave Ratio

11. Revision history

Table 12. Revision history

Document ID	Release date	Data sheet status	Change notice	Supersedes
BLF574_2	20090224	Product data sheet	-	BLF574_1
Modifications:	• Data sheet status updated from Preliminary to Product			
BLF574_1	20081208	Preliminary data sheet	-	-

12. Legal information

12.1 Data sheet status

Document status ^{[1][2]}	Product status ^[3]	Definition
Objective [short] data sheet	Development	This document contains data from the objective specification for product development.
Preliminary [short] data sheet	Qualification	This document contains data from the preliminary specification.
Product [short] data sheet	Production	This document contains the product specification.

[1] Please consult the most recently issued document before initiating or completing a design.

[2] The term 'short data sheet' is explained in section "Definitions".

[3] The product status of device(s) described in this document may have changed since this document was published and may differ in case of multiple devices. The latest product status information is available on the Internet at URL <http://www.nxp.com>.

12.2 Definitions

Draft — The document is a draft version only. The content is still under internal review and subject to formal approval, which may result in modifications or additions. NXP Semiconductors does not give any representations or warranties as to the accuracy or completeness of information included herein and shall have no liability for the consequences of use of such information.

Short data sheet — A short data sheet is an extract from a full data sheet with the same product type number(s) and title. A short data sheet is intended for quick reference only and should not be relied upon to contain detailed and full information. For detailed and full information see the relevant full data sheet, which is available on request via the local NXP Semiconductors sales office. In case of any inconsistency or conflict with the short data sheet, the full data sheet shall prevail.

12.3 Disclaimers

General — Information in this document is believed to be accurate and reliable. However, NXP Semiconductors does not give any representations or warranties, expressed or implied, as to the accuracy or completeness of such information and shall have no liability for the consequences of use of such information.

Right to make changes — NXP Semiconductors reserves the right to make changes to information published in this document, including without limitation specifications and product descriptions, at any time and without notice. This document supersedes and replaces all information supplied prior to the publication hereof.

Suitability for use — NXP Semiconductors products are not designed, authorized or warranted to be suitable for use in medical, military, aircraft, space or life support equipment, nor in applications where failure or malfunction of an NXP Semiconductors product can reasonably be expected to result in personal injury, death or severe property or environmental

damage. NXP Semiconductors accepts no liability for inclusion and/or use of NXP Semiconductors products in such equipment or applications and therefore such inclusion and/or use is at the customer's own risk.

Applications — Applications that are described herein for any of these products are for illustrative purposes only. NXP Semiconductors makes no representation or warranty that such applications will be suitable for the specified use without further testing or modification.

Limiting values — Stress above one or more limiting values (as defined in the Absolute Maximum Ratings System of IEC 60134) may cause permanent damage to the device. Limiting values are stress ratings only and operation of the device at these or any other conditions above those given in the Characteristics sections of this document is not implied. Exposure to limiting values for extended periods may affect device reliability.

Terms and conditions of sale — NXP Semiconductors products are sold subject to the general terms and conditions of commercial sale, as published at <http://www.nxp.com/profile/terms>, including those pertaining to warranty, intellectual property rights infringement and limitation of liability, unless explicitly otherwise agreed to in writing by NXP Semiconductors. In case of any inconsistency or conflict between information in this document and such terms and conditions, the latter will prevail.

No offer to sell or license — Nothing in this document may be interpreted or construed as an offer to sell products that is open for acceptance or the grant, conveyance or implication of any license under any copyrights, patents or other industrial or intellectual property rights.

Quick reference data — The Quick reference data is an extract of the product data given in the Limiting values and Characteristics sections of this document, and as such is not complete, exhaustive or legally binding.

12.4 Trademarks

Notice: All referenced brands, product names, service names and trademarks are the property of their respective owners.

13. Contact information

For more information, please visit: <http://www.nxp.com>

For sales office addresses, please send an email to: salesaddresses@nxp.com

14. Contents

1	Product profile	1
1.1	General description	1
1.2	Features	1
1.3	Applications	1
2	Pinning information	2
3	Ordering information	2
4	Limiting values	2
5	Thermal characteristics	2
6	Characteristics	3
6.1	Ruggedness in class-AB operation	4
7	Application information	5
7.1	RF performance	5
7.1.1	1-Tone CW	5
7.1.2	2-Tone CW	6
7.1.3	Application circuit	7
7.2	Reliability	9
8	Test information	10
8.1	Impedance information	10
8.2	RF performance	11
8.2.1	1-Tone CW	11
8.2.2	2-Tone CW	12
8.2.3	Test circuit	13
9	Package outline	15
10	Abbreviations	16
11	Revision history	16
12	Legal information	17
12.1	Data sheet status	17
12.2	Definitions	17
12.3	Disclaimers	17
12.4	Trademarks	17
13	Contact information	17
14	Contents	18

Please be aware that important notices concerning this document and the product(s) described herein, have been included in section 'Legal information'.



© NXP B.V. 2009.

All rights reserved.

For more information, please visit: <http://www.nxp.com>

For sales office addresses, please send an email to: salesaddresses@nxp.com

Date of release: 24 February 2009

Document identifier: BLF574_2