

DUAL EQUALIZER AMPLIFIER WITH ALC

The KA2224 is a monolithic integrated circuit consisting of a dual equalizer amplifier with ALC, and it is suitable for stereo radio cassettes.

FEATURES

- Dual equalizer amplifier with a built-in ALC circuit.
- Recording amp available because of high gain characteristic (Variable monitor possible).
- Good channel separation (CS = 50dB Typ).
- Quick stabilization after power on.
- Capable of direct meter driving and ALC transistor.
- Good ALC response balance between channels.
- Wide operating supply voltage range: $V_{CC} = 4V \sim 13V$

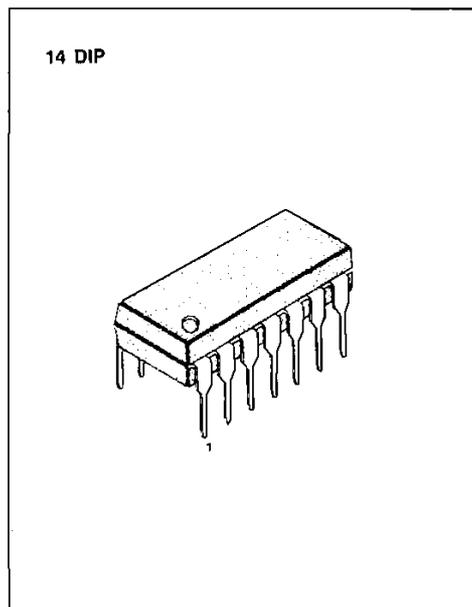

ORDERING INFORMATION

Device	Package	Operating Temperature
KA2224	14 DIP	-20°C ~ +70°C

BLOCK DIAGRAM

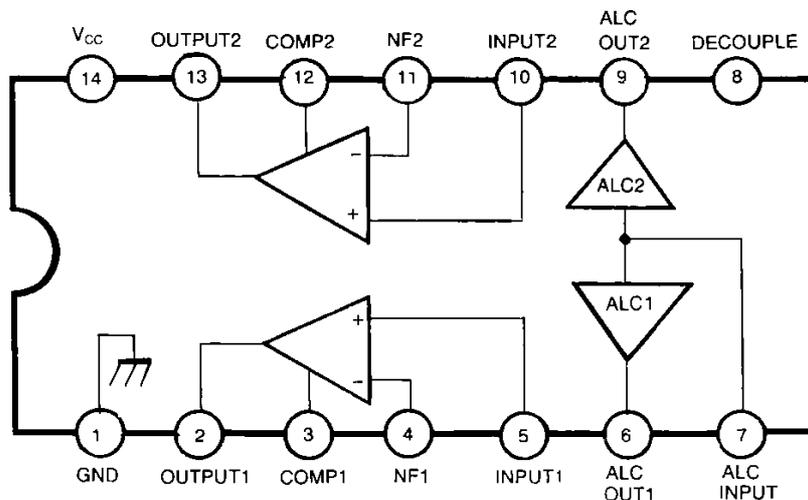

Fig. 1

ABSOLUTE MAXIMUM RATINGS (T_a = 25°C)

Characteristic	Symbol	Value	Unit
Supply Voltage	V _{CC}	14	V
Power Dissipation	P _D	600	mW
Operating Temperature	T _{OPR}	- 20 ~ + 70	°C
Storage Temperature	T _{STG}	- 40 ~ + 125	°C
ALC TR Maximum Current		3.5	mA

ELECTRICAL CHARACTERISTICS(T_a = 25°C, V_{CC} = 5V, R_L = 10KΩ, f = 1KHz: play, R_L = 680Ω: Recording)

Characteristic	Symbol	Test Conditions	Min	Typ	Max	Unit
Quiescent Circuit Current	I _{CCO}	V _I = 0		4.5	10	mA
Open Loop Voltage Gain	G _{VO}			85		dB
Closed Loop Voltage Gain	G _{VC1}	Play		40		dB
	G _{VC2}	Record		58		dB
Output Voltage	V _O	THD=1%, Play	0.9	1.2		V
Total Harmonic Distortion	THD	V _O =0.5V, Play		0.1	1.0	%
Input Resistance	R _I		21	30		KΩ
Equivalent Input Noise Voltage	V _{NI}	BW (-3dB) =20Hz ~ 20KHz		1.0	2.0	μV
Cross Talk	CT	R _G = 2.2KΩ	40	50		dB
ALC Range	ΔV _{ALC}	V _I = - 60dBm, Record	35	45		dB
ALC Balance	CB _{ALC}	V _I = - 20dBm, Record		0	2.0	dB
ALC Distortion	THD _{ALC}	V _I = - 20dBm, Record		0.5	2.0	%

TEST CIRCUIT

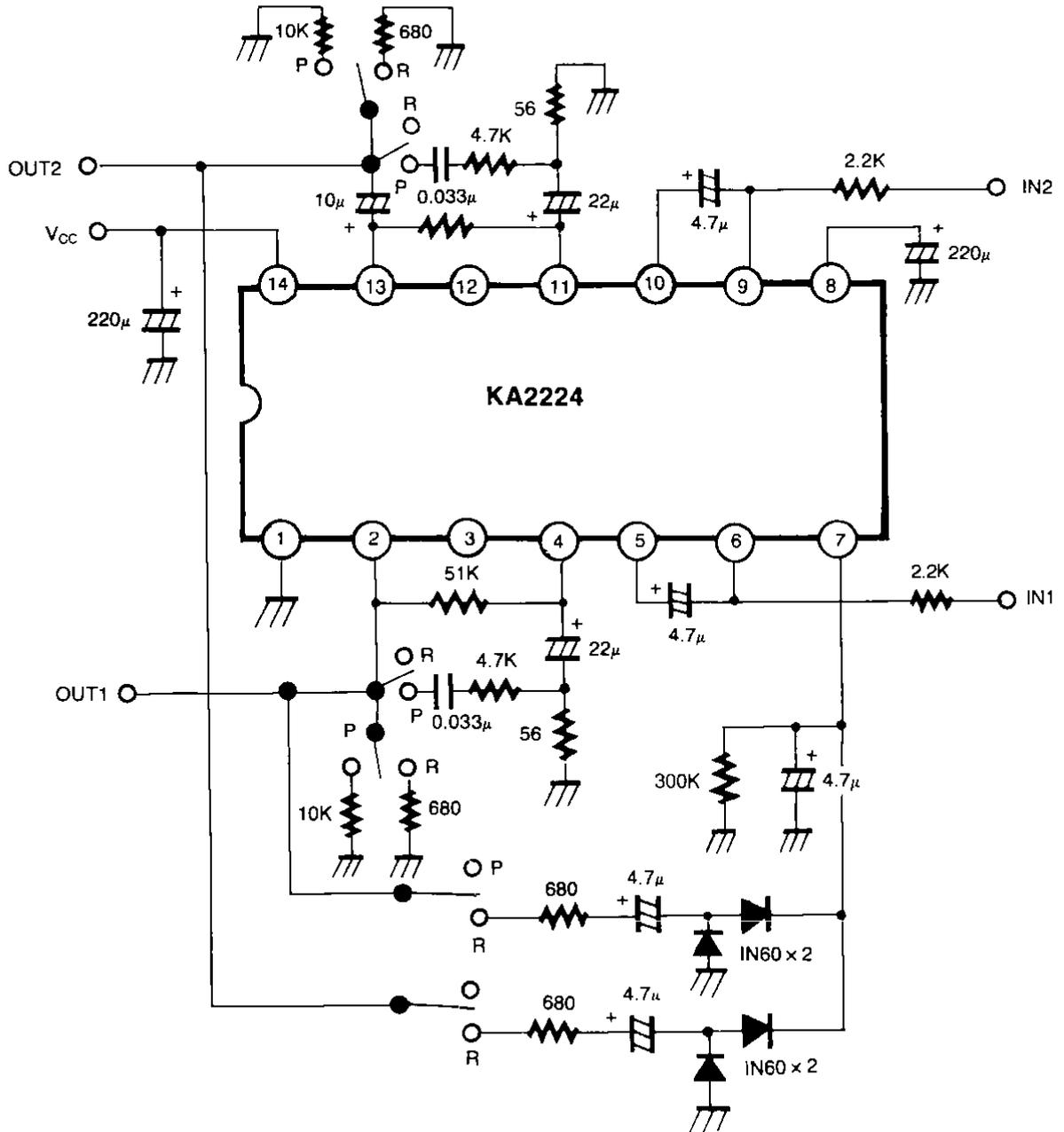
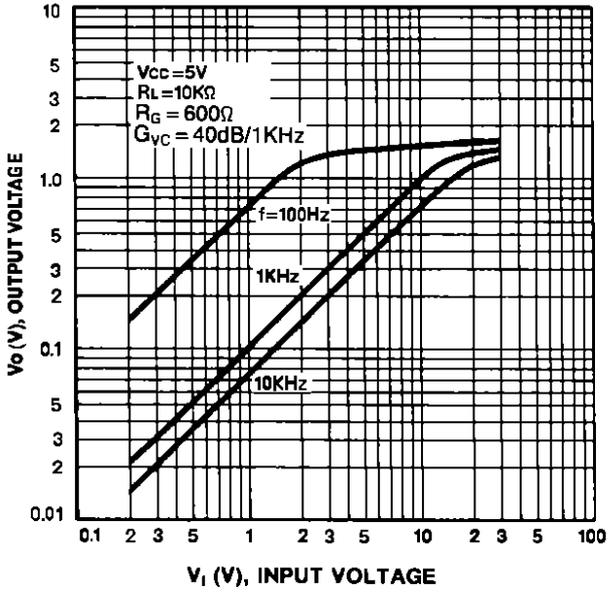
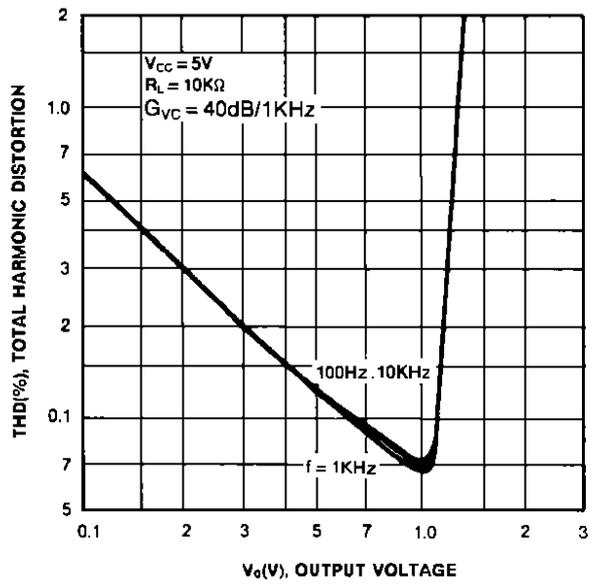

Fig. 2

OUTPUT VOLTAGE-INPUT VOLTAGE



TOTAL HARMONIC DISTORTION-OUTPUT VOLTAGE



TOTAL HARMONIC DISTORTION-SUPPLY VOLTAGE

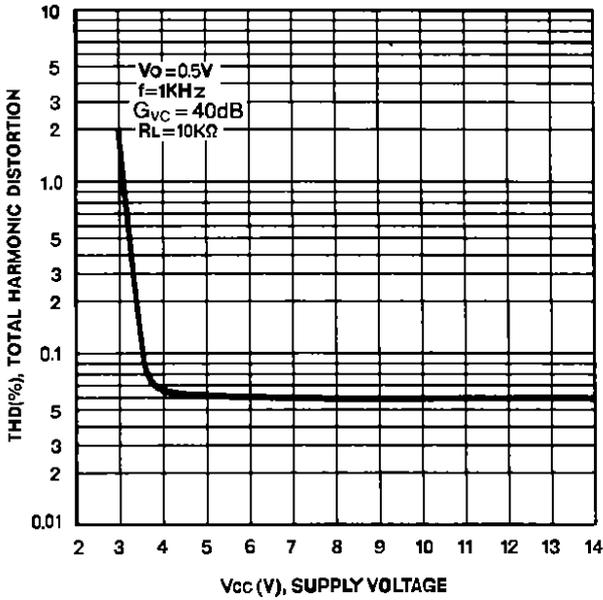

**ALC OUTPUT VOLTAGE — INPUT VOLTAGE
ALC TOTAL HARMONIC DISTORTION**

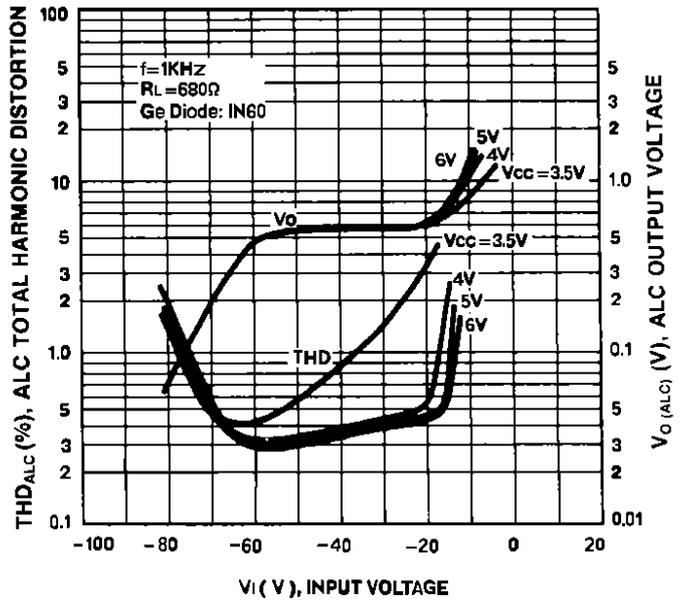

VOLTAGE GAIN-FREQUENCY

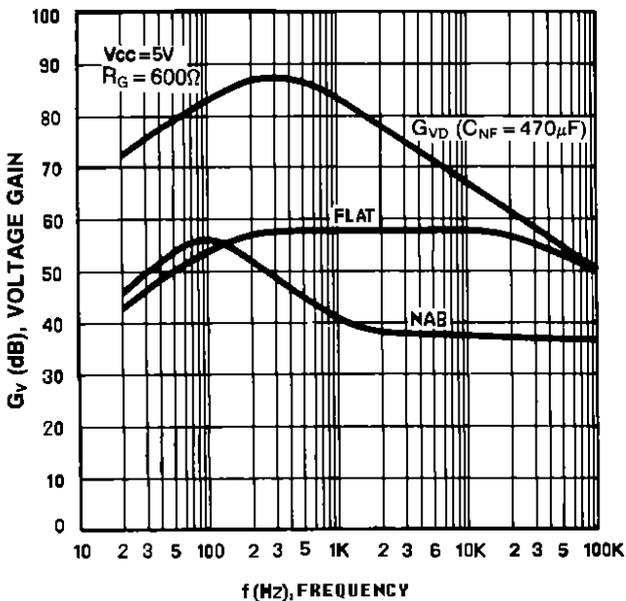

EQUIVALENT INPUT NOISE VOLTAGE -GENERATOR RESISTANCE

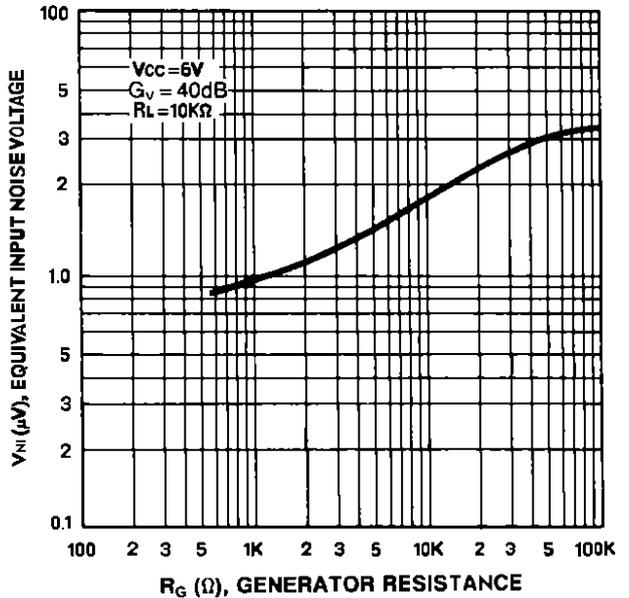

RIPPLE REJECTION RATIO-SUPPLY VOLTAGE

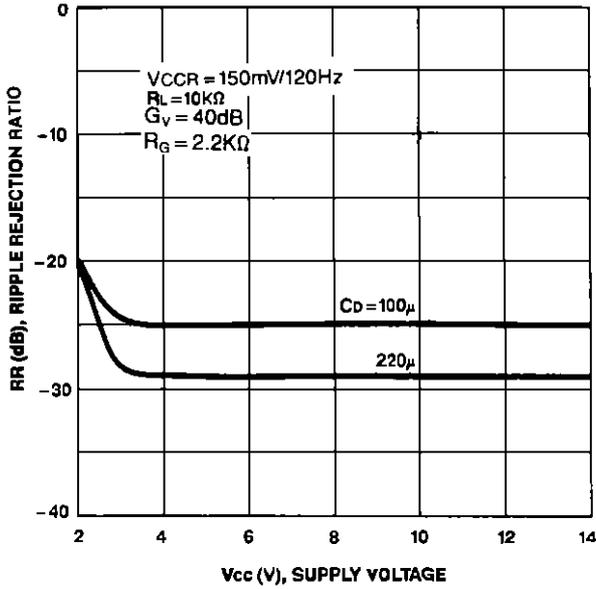

CROSS TALK-FREQUENCY

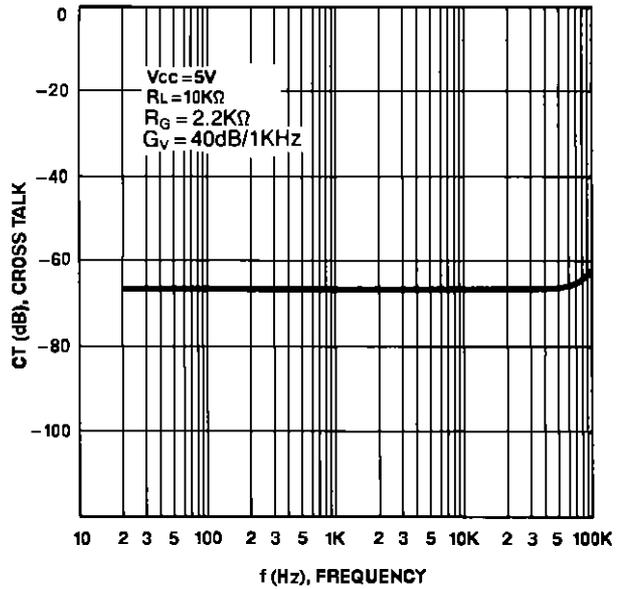

QUIESCENT CIRCUIT CURRENT-SUPPLY VOLTAGE

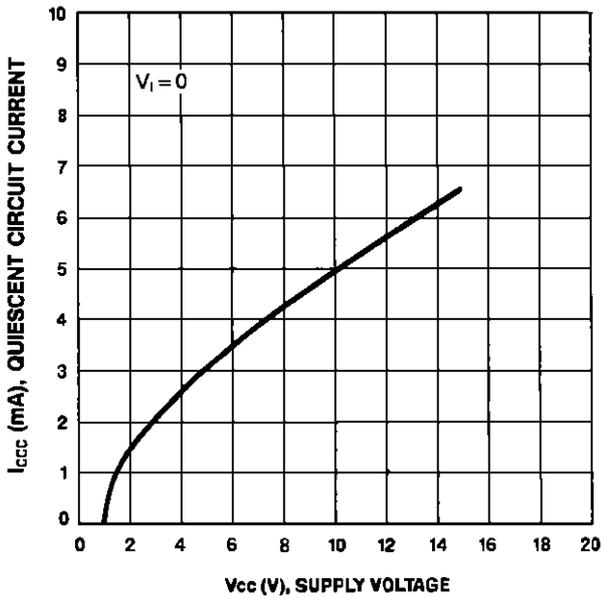

CENTER POINT VOLTAGE, -SUPPLY VOLTAGE OUTPUT VOLTAGE

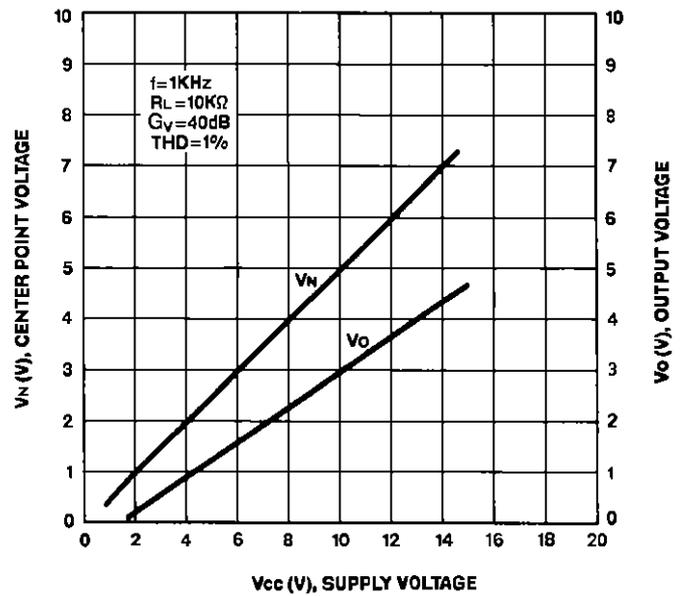

OUTPUT VOLTAGE-AMBIENT TEMPERATURE

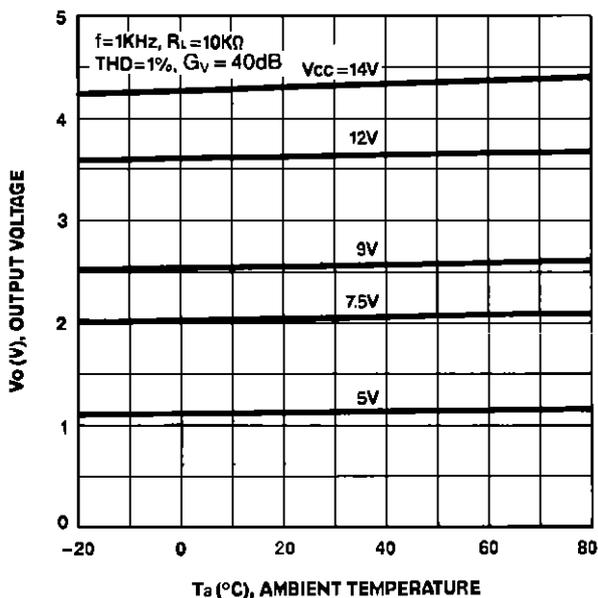

VOLTAGE GAIN-AMBIENT TEMPERATURE

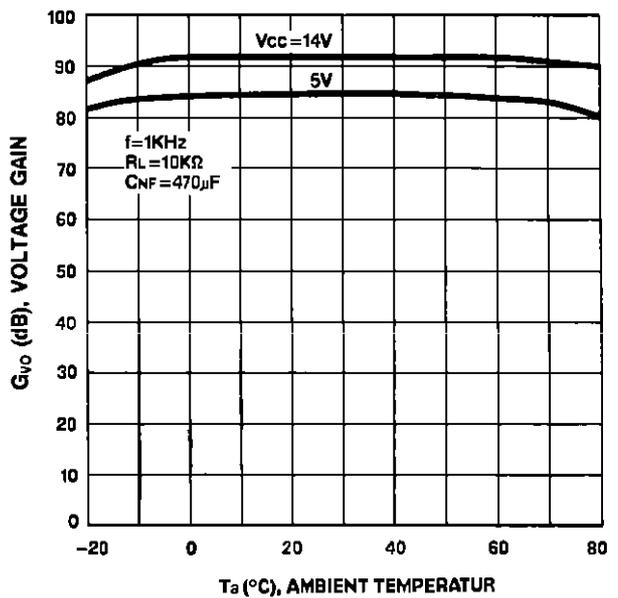

APPLICATION INFORMATION

1. Closed Loop Voltage Gain

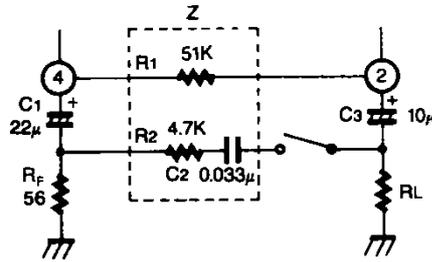

Fig. 4

SW on: play
off: record

A. Playback amplifier

$$G_v = 20 \log \frac{Z}{R_F} \text{ (dB) at } f = 1\text{KHz, } G_v = 42\text{dB (Typ) } Z = R_1 // \left(R_2 + \frac{1}{2\pi f \cdot C_2} \right)$$

B. Recording amplifier

$$G_v = 20 \log \frac{R_1}{R_F} \text{ (dB) at } f = 1\text{KHz, } G_v = 58\text{dB (Typ)}$$

2. ALC Circuit

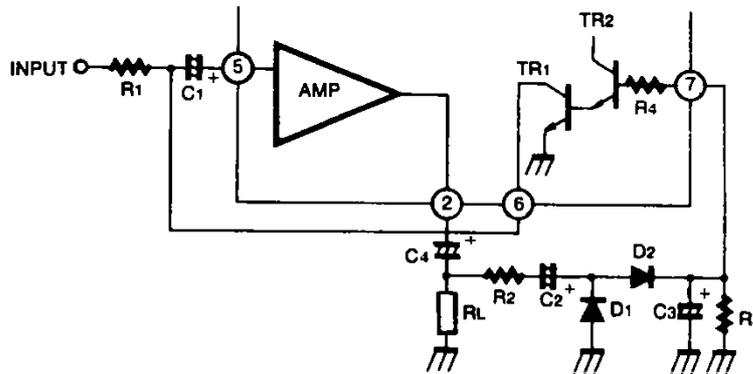

Fig. 5

The ALC circuit is consist of TR₁, TR₂ and some external components. The output level of the amplifier is rectified by external circuits. Since this DC level is applied to the ALC input terminal (Pin 7), the impedance between the collector and emitter of TR₁ can change its value, therefore the pre-amplifier input level can be controlled.